

The Rendering Equation

Computer Graphics
CMU 15-462/15-662

Recap, with units

Radiant Energy

(total number of hits)

Joules (J)

Radiant Energy Density

(hits per unit area)

Joules per square meter (J/m²)

Radiant Flux

(total hits per second)

Joules per second (J/s) = Watts (W)

Φ

Radiant Flux Density

a.k.a. *Irradiance*

(hits per second per unit area)

Watts per square meter (W/m²)

E

Recap: Radiance

- Radiance is the solid angle density of irradiance

$$L(p, \omega) = \lim_{\Delta \rightarrow 0} \frac{\Delta E_\omega(p)}{\Delta \omega} = \frac{dE_\omega(p)}{d\omega} \left[\frac{\text{W}}{\text{m}^2 \text{ sr}} \right]$$

where E_ω denotes that the differential surface area is oriented to face in the direction ω

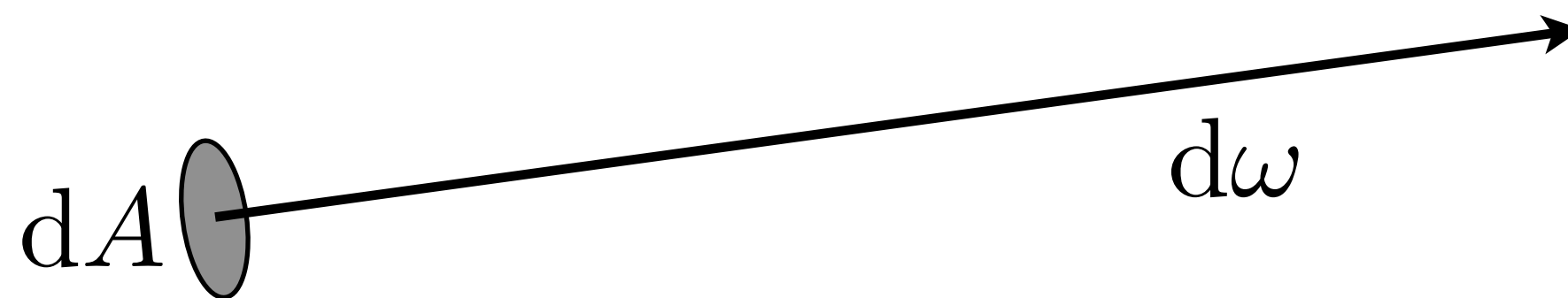

In other words, radiance is energy along a ray defined by origin point p and direction ω

Energy per unit time per unit area per unit solid angle...!

Recap: What is Radiance?

- Radiance is a fundamental field quantity that characterizes the distribution of light in an environment
 - Radiance is the quantity associated with a ray
 - **Rendering is all about computing radiance**
- Radiance is constant along a ray (in a vacuum)
- A pinhole camera measures radiance

Surface Radiance

- **Equivalently,**

$$L(p, \omega) = \frac{dE(p)}{d\omega \cos \theta} = \frac{d^2\Phi(p)}{dA d\omega \cos \theta}$$

- **Previous slide described measuring radiance at a surface oriented in ray direction**
 - **cos(theta) accounts for different surface orientation**

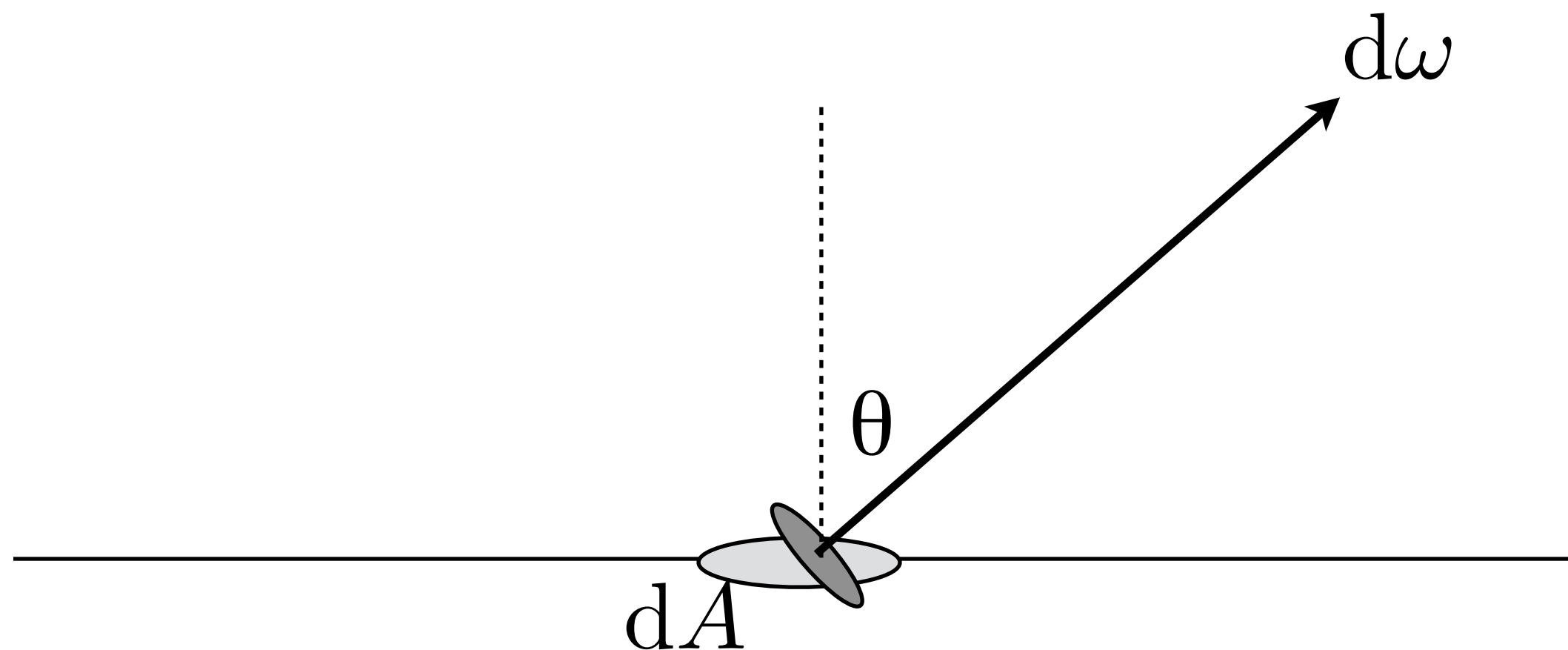

Recap: What is radiance?

- Radiance at point p in direction N is radiant energy (“#hits”) per unit time, per solid angle, per unit area perpendicular to N .

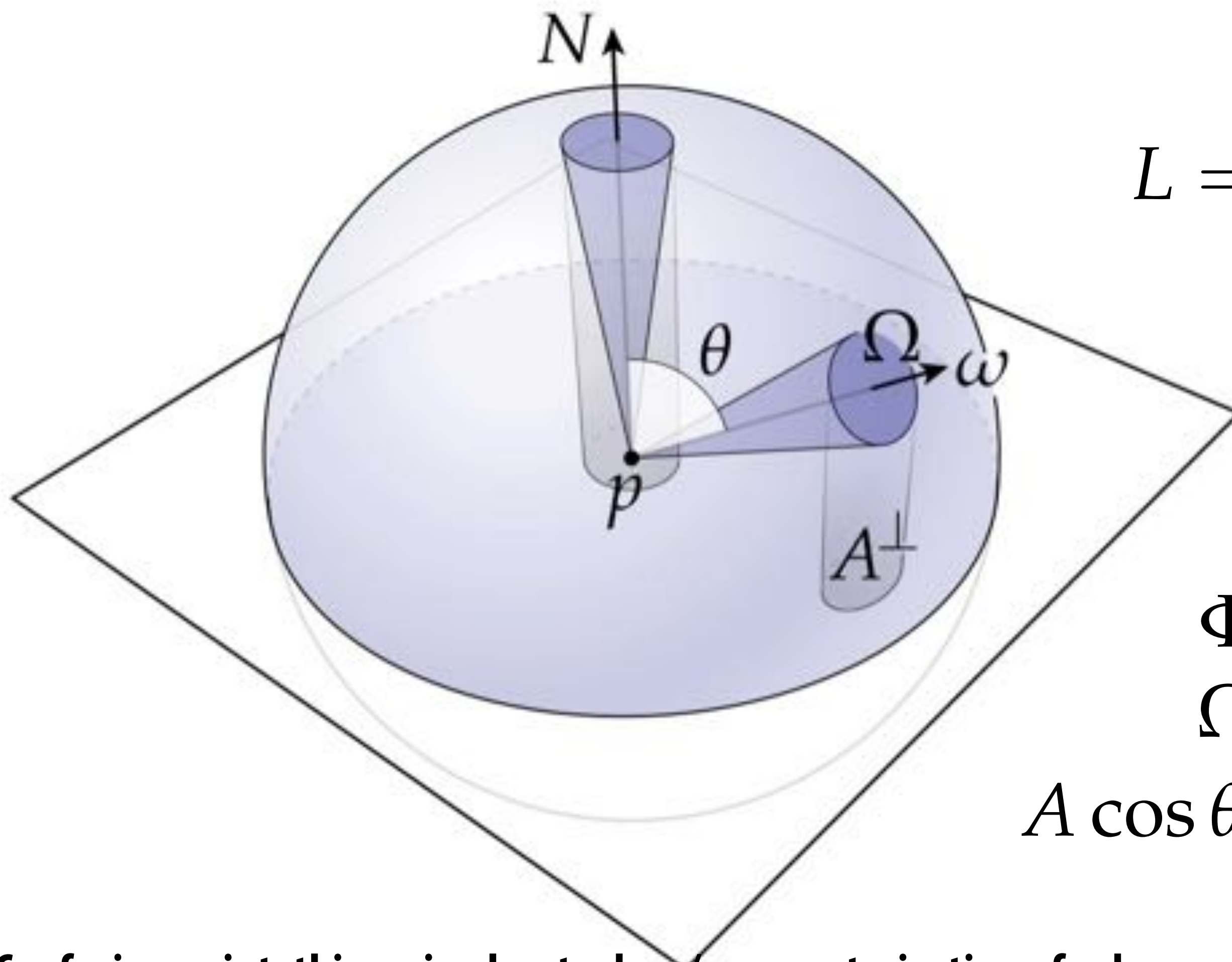

$$L = \frac{\partial^2 \Phi}{\partial \Omega \partial A \cos \theta}$$

Φ — radiant flux

Ω — solid angle

$A \cos \theta$ — projected area*

*Confusing point: this cosine has to do w/ parameterization of sphere, not Lambertian reflectance

Incident vs. Exitant Radiance

- Often need to distinguish between incident radiance and exitant radiance functions at a point on a surface

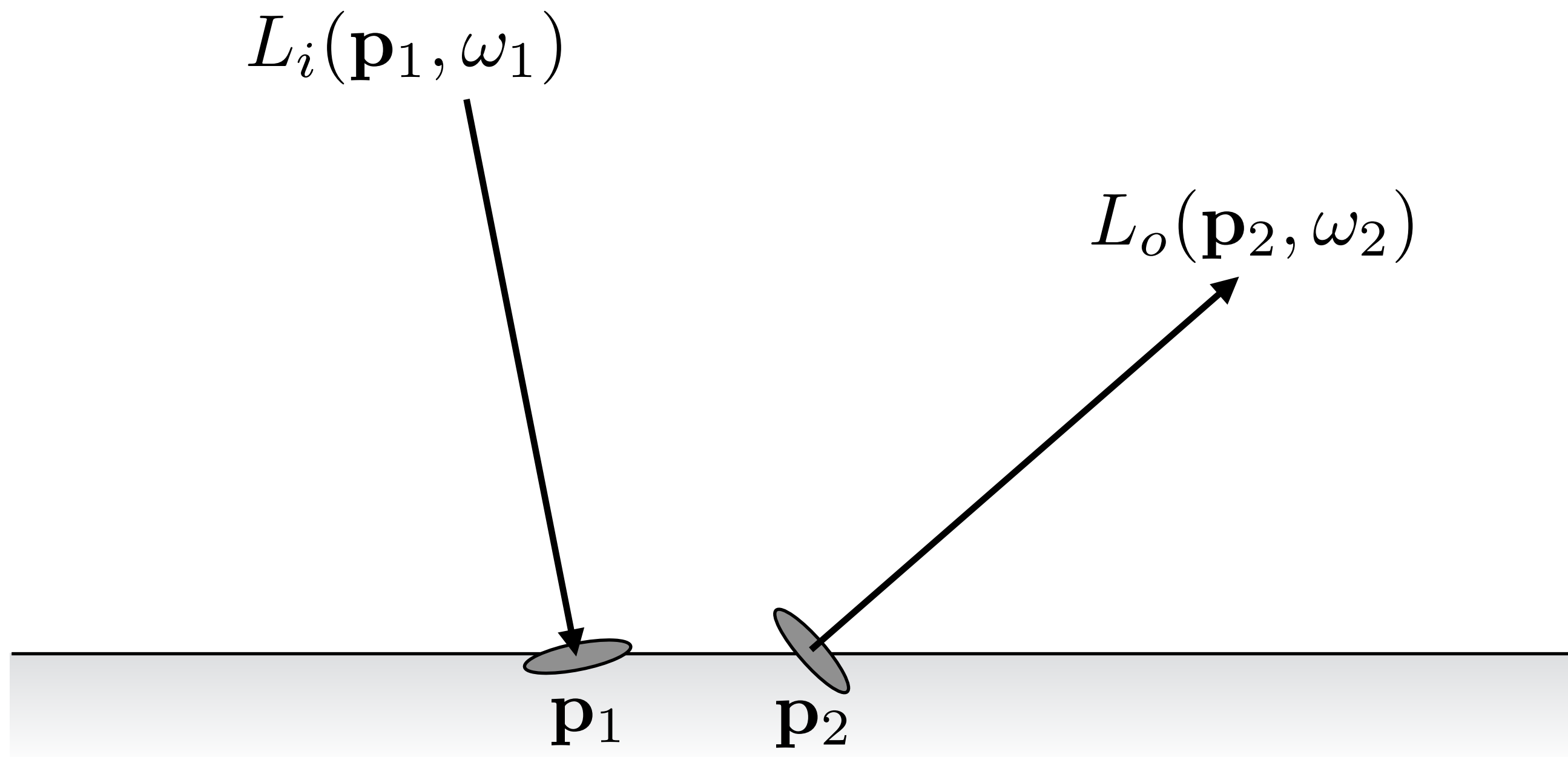

In general: $L_i(\mathbf{p}, \omega) \neq L_o(\mathbf{p}, \omega)$

Incident vs. Exitant Radiance

INCIDENT



EXITANT



In both cases: intensity of illumination is highly dependent on **direction (not just location in space or moment in time).**

Irradiance from the environment

Computing flux per unit area on surface, due to incoming light from all directions:

$$E(\mathbf{p}) = \int_{H^2} L_i(\mathbf{p}, \omega) \cos \theta d\omega$$

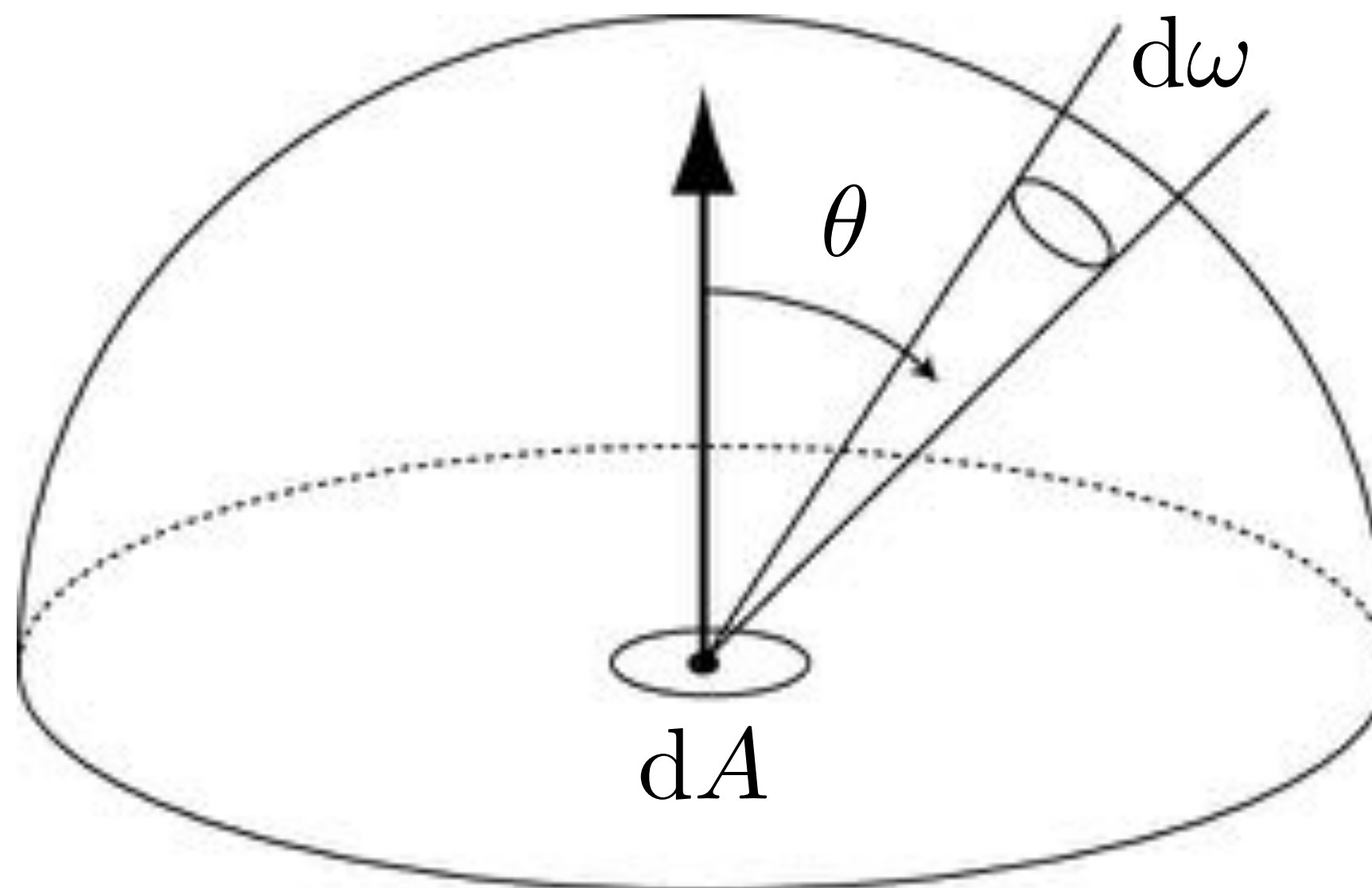

(This is what we often want to do for rendering!)

Radiance and Irradiance

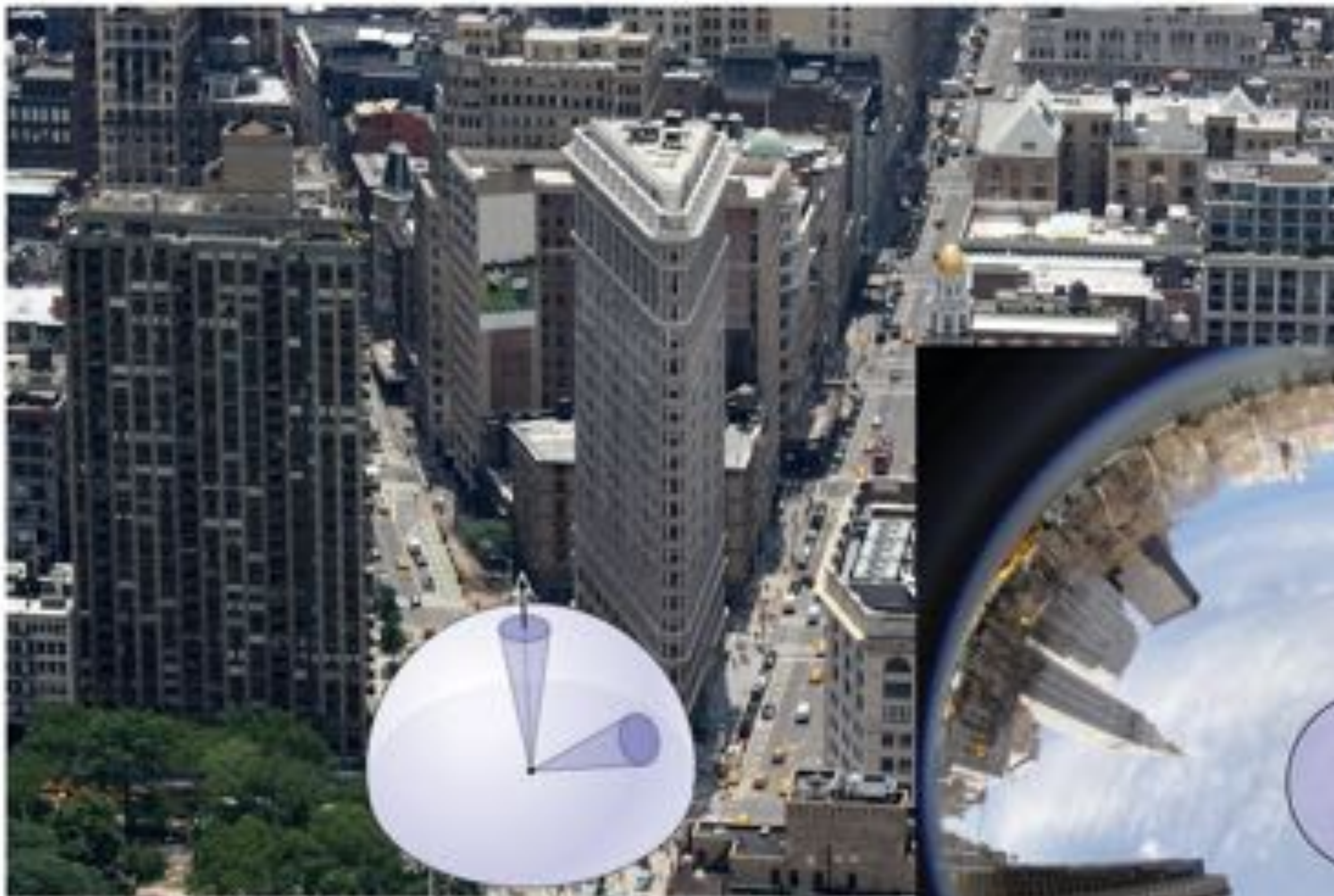

irradiance

radiance in direction ω

$$E = \int_{\mathbb{H}^2} L(\omega) \cos \theta \, d\omega$$

angle between ω and normal

Irradiance and effect of area lights

Generally “softer” appearance than point lights:

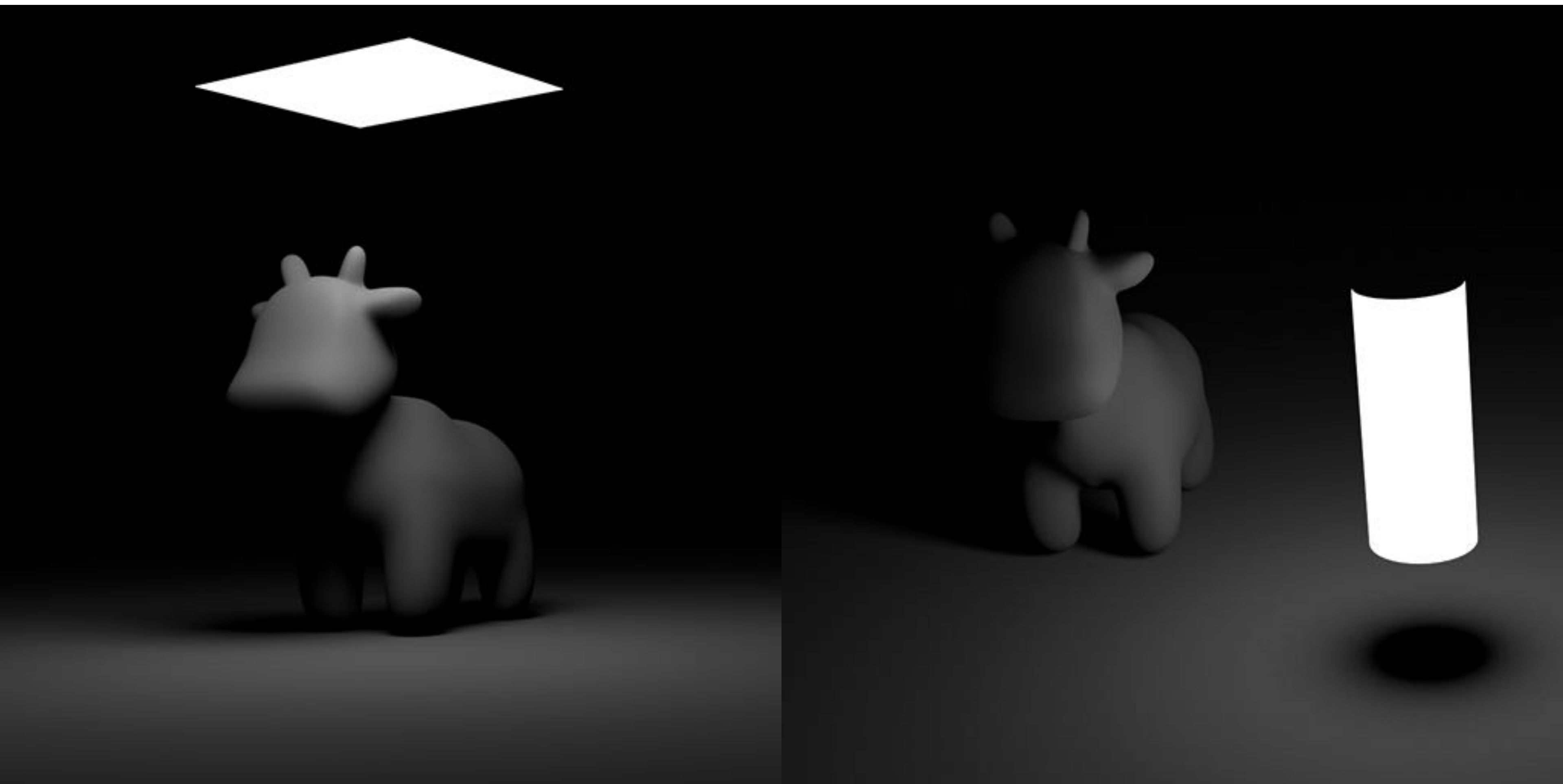

...and better model of real-world lights!

Exitant Radiance

How do we measure illumination?

EXITANT



Measuring illumination: radiant intensity

- Power per solid angle emanating from a point source

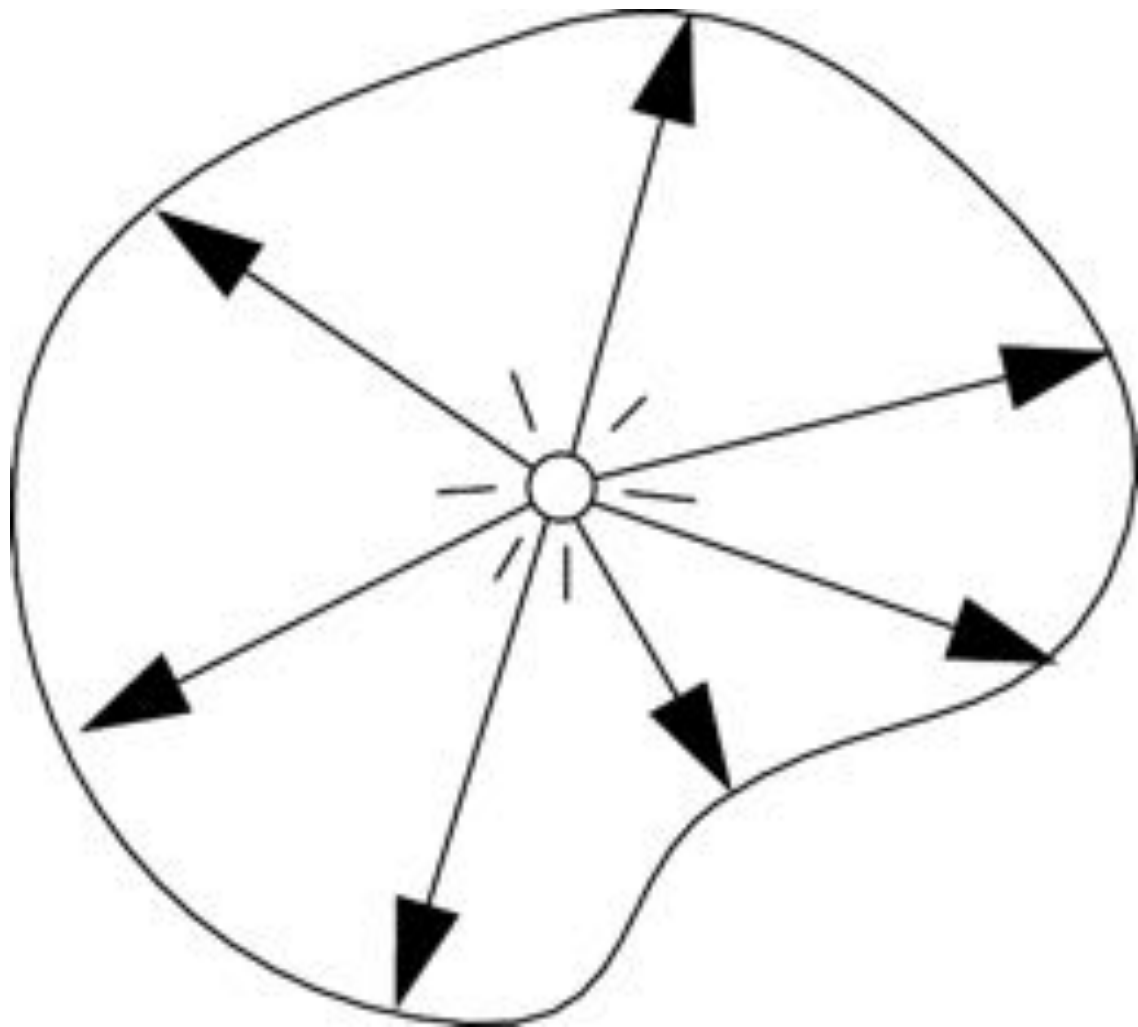

$$I(\omega) = \frac{d\Phi}{d\omega} \left[\frac{\text{W}}{\text{sr}} \right]$$

More realistic light models via “goniometry”

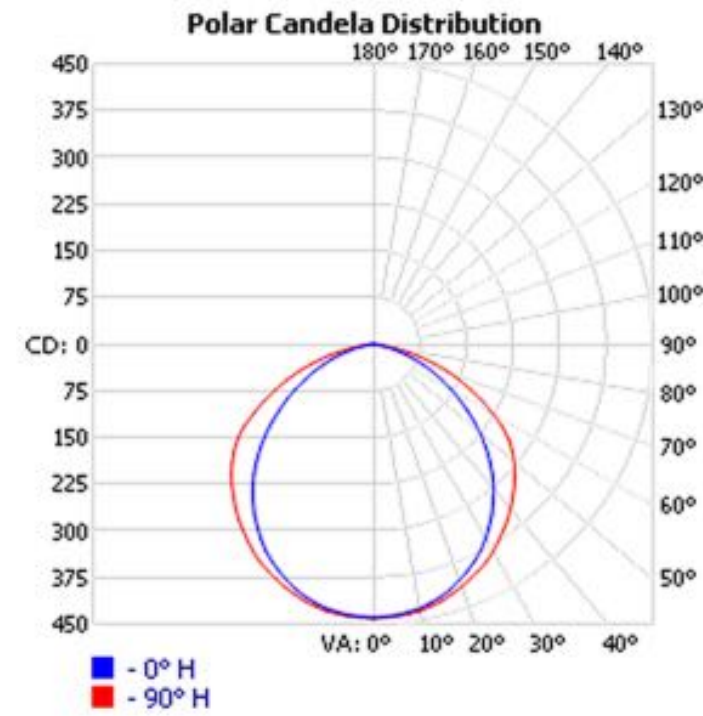
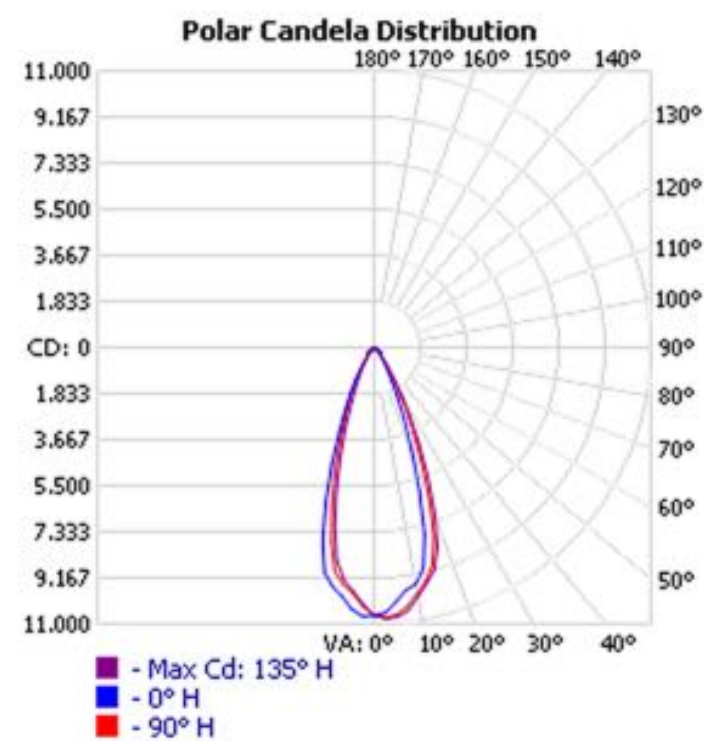

Goniometric diagram measures light intensity as function of angle.

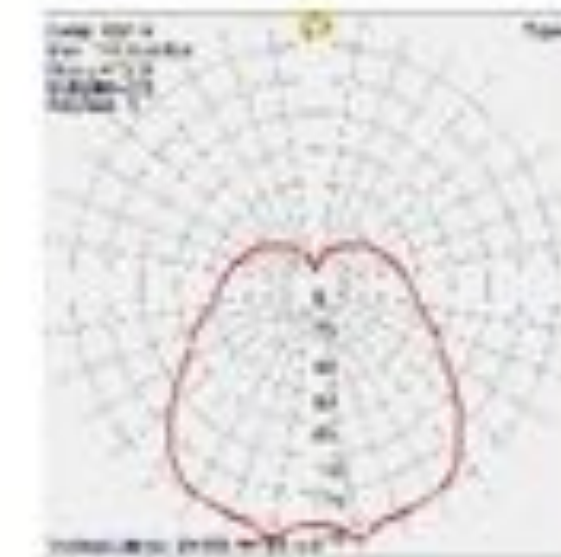

<http://www.mpi-inf.mpg.de/resources/mpimodel/v1.0/luminaires/index.html>

<http://www.visual-3d.com/tools/photometricviewer/>

Question du jour:

**How do we use all this stuff
to generate images?**

The Rendering Equation

- Core functionality of photorealistic renderer is to estimate radiance at a given point \mathbf{p} , in a given direction ω_o
- Summed up by the **rendering equation** (Kajiya):

Diagram illustrating the rendering equation with annotations:

$$L_o(\mathbf{p}, \omega_o) = L_e(\mathbf{p}, \omega_o) + \int_{\mathcal{H}^2} f_r(\mathbf{p}, \omega_i \rightarrow \omega_o) L_i(\mathbf{p}, \omega_i) \cos \theta d\omega_i$$

Annotations:

- outgoing/observed radiance: $L_o(\mathbf{p}, \omega_o)$
- point of interest: \mathbf{p}
- direction of interest: ω_o
- emitted radiance (e.g., light source): $L_e(\mathbf{p}, \omega_o)$
- all directions in hemisphere: $\int_{\mathcal{H}^2}$
- scattering function: $f_r(\mathbf{p}, \omega_i \rightarrow \omega_o)$
- incoming radiance: $L_i(\mathbf{p}, \omega_i)$
- incoming direction: ω_i
- angle between incoming direction and normal: $\cos \theta$

Key challenge: to evaluate incoming radiance, we have to compute yet another integral. I.e., rendering equation is recursive.

Recursive Raytracing

- **Basic strategy: recursively evaluate rendering equation!**

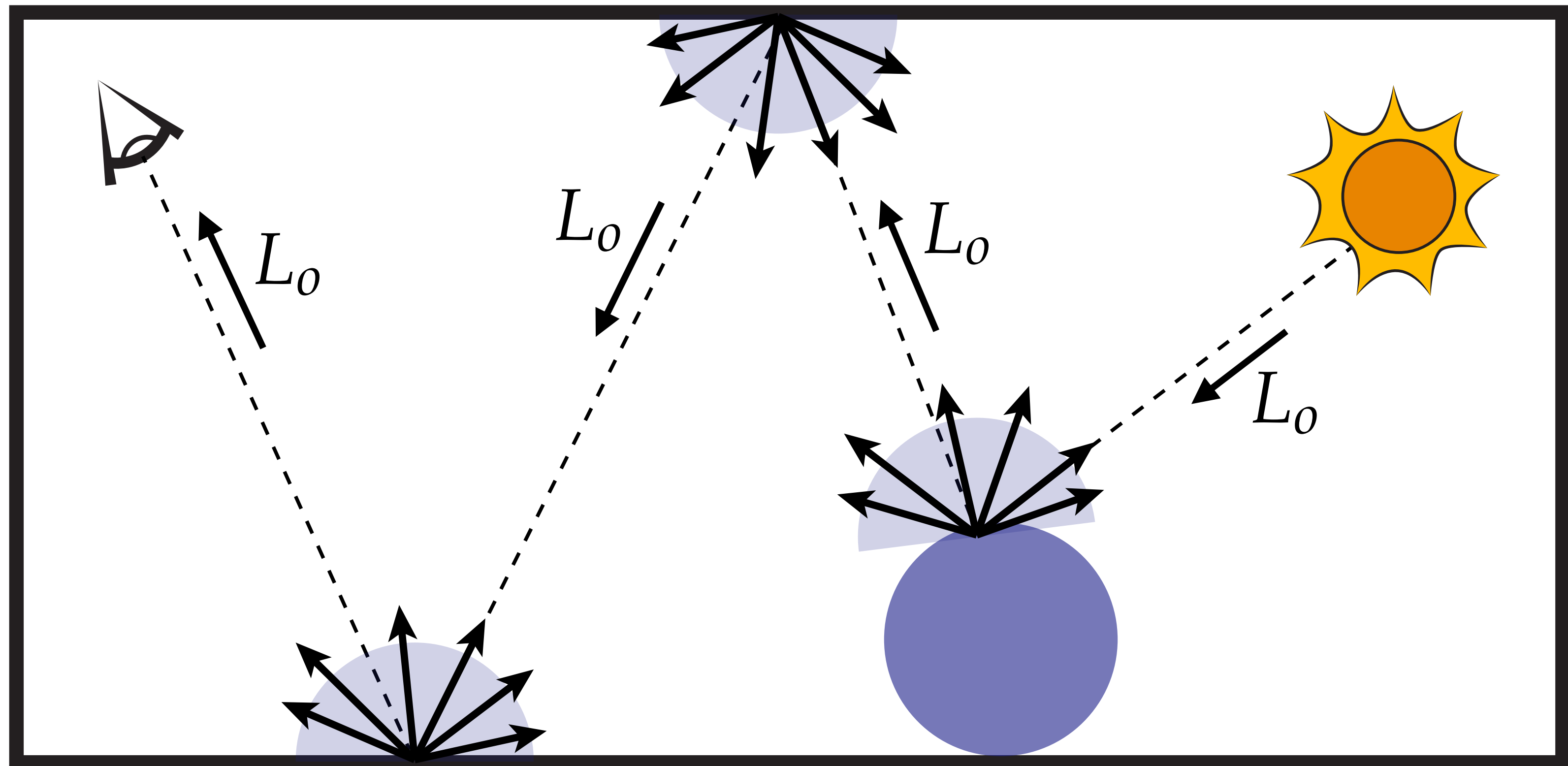

(This is why you're writing a ray tracer—rasterizer isn't enough!)

Renderer measures radiance along a ray

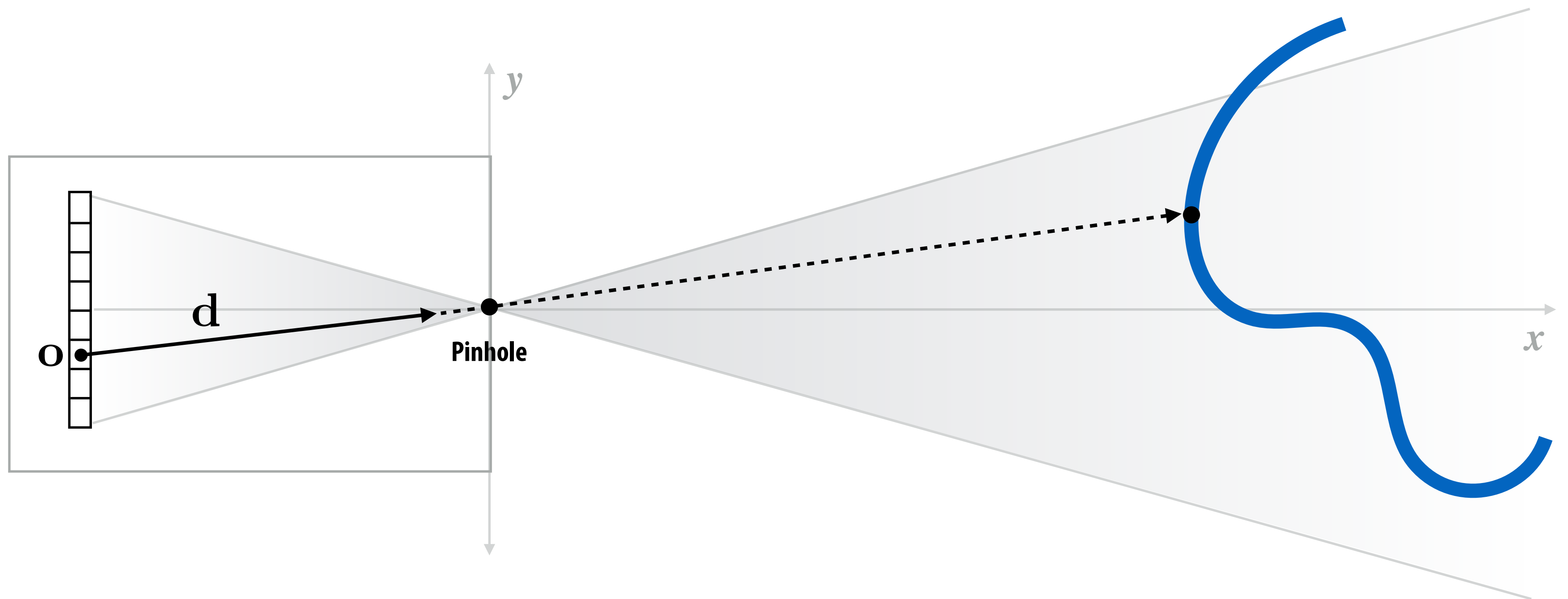

At each “bounce,” want to measure radiance traveling in the direction opposite the ray direction.

Renderer measures radiance along a ray

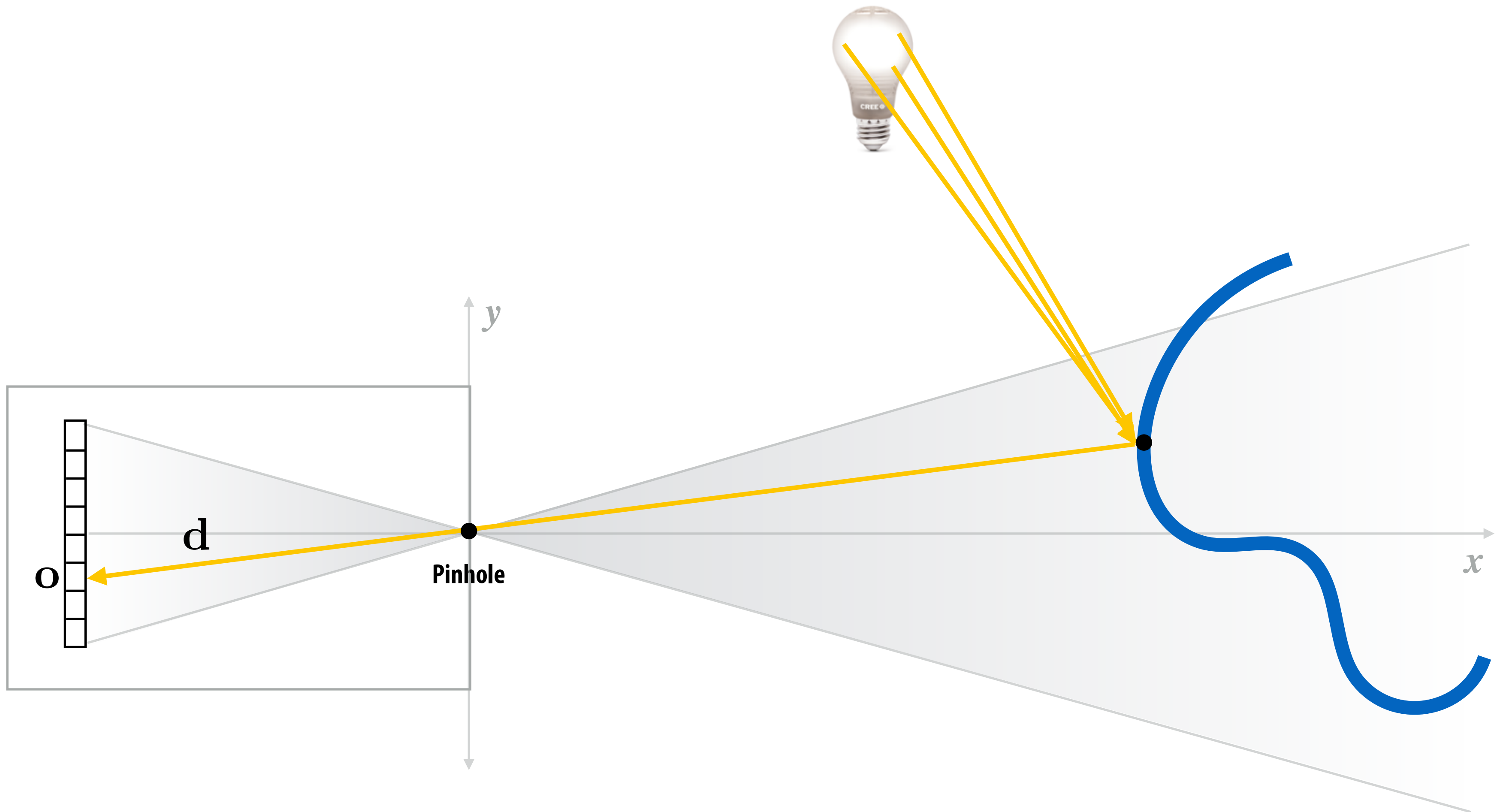

Radiance entering camera in direction d = light from scene light sources that is reflected off surface in direction d .

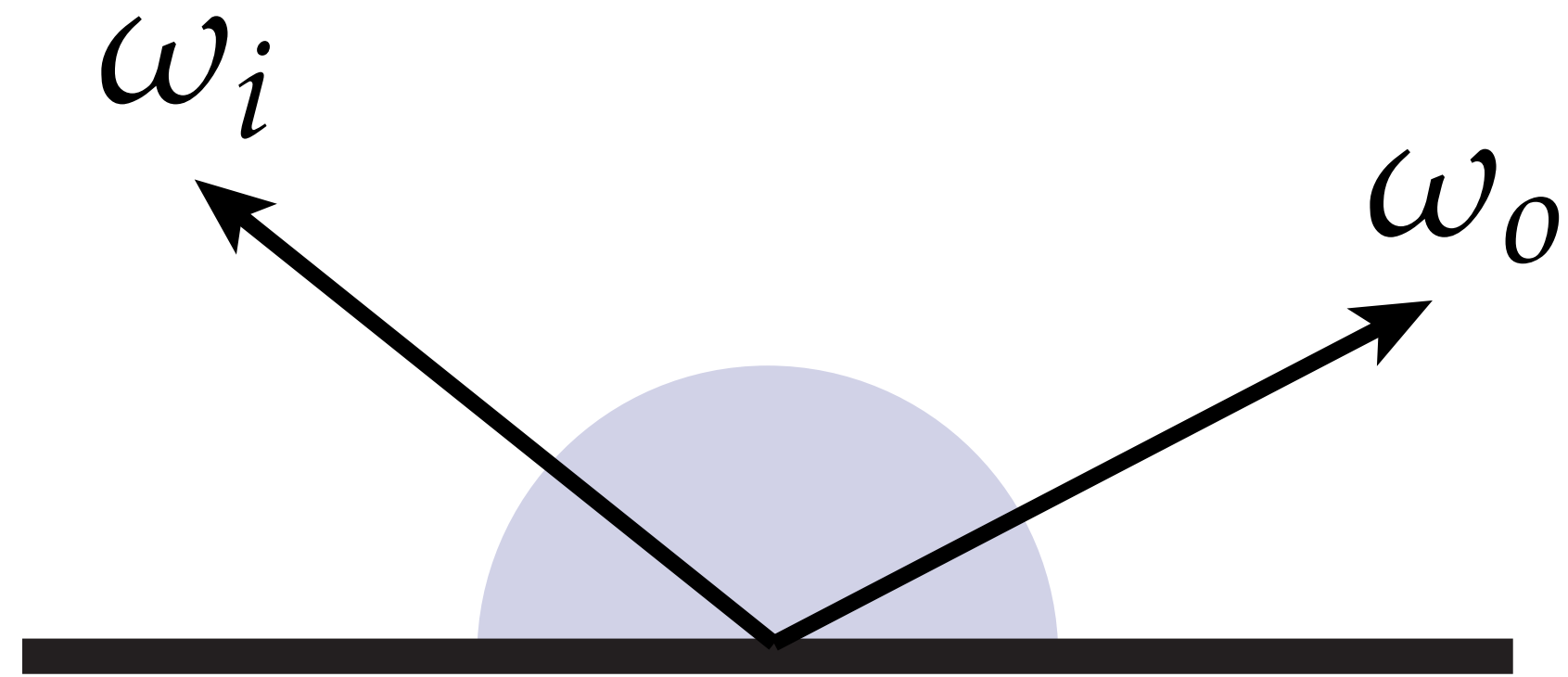

How does reflection of light affect the outgoing radiance?

$$L_o(\mathbf{p}, \omega_o) = \int_{\mathcal{H}^2} f_r(\mathbf{p}, \omega_i, \omega_o) L_i(\mathbf{p}, \omega_i) \cos \theta \, d\omega_i$$

Reflection models

- Reflection is the process by which light incident on a surface interacts with the surface such that it leaves on the incident (same) side without change in frequency
- Choice of reflection function determines surface appearance



Some basic reflection functions

- **Ideal specular**

Perfect mirror

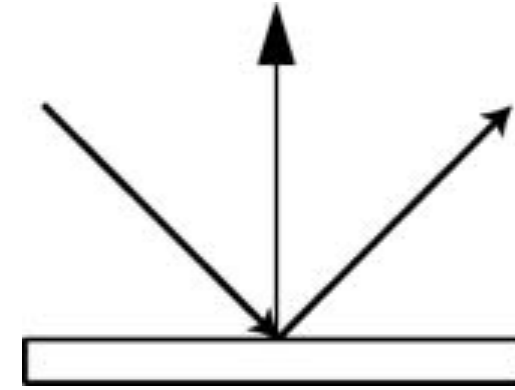

- **Ideal diffuse**

Uniform reflection in all directions

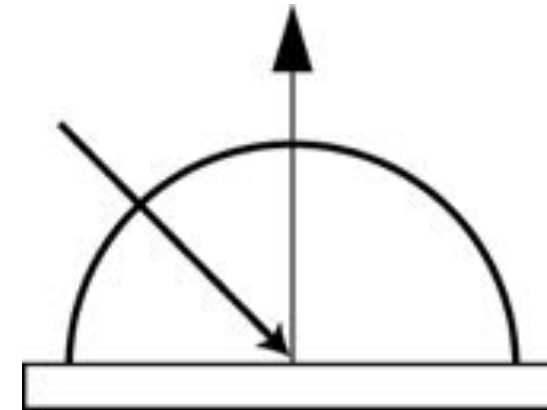

- **Glossy specular**

Majority of light distributed in reflection direction

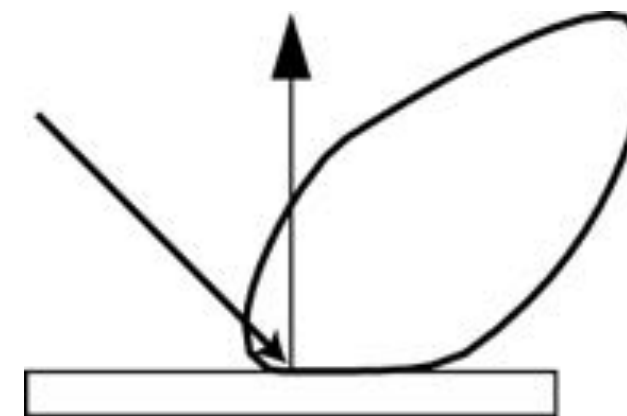

- **Retro-reflective**

Reflects light back toward source

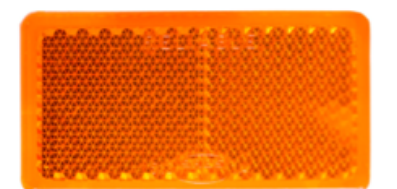
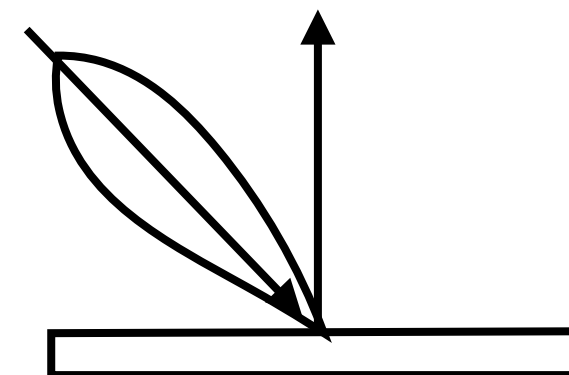

Diagrams illustrate how incoming light energy from given direction is reflected in various directions.

Materials: diffuse



Materials: plastic



Materials: red semi-gloss paint



Materials: Ford mystic lacquer paint



Materials: mirror



Materials: gold



Materials



Models of Scattering

- How can we model “scattering” of light?
- Many different things that could happen to a photon:

- bounces off surface
- transmitted through surface
- bounces around inside surface
- absorbed & re-emitted
- ...

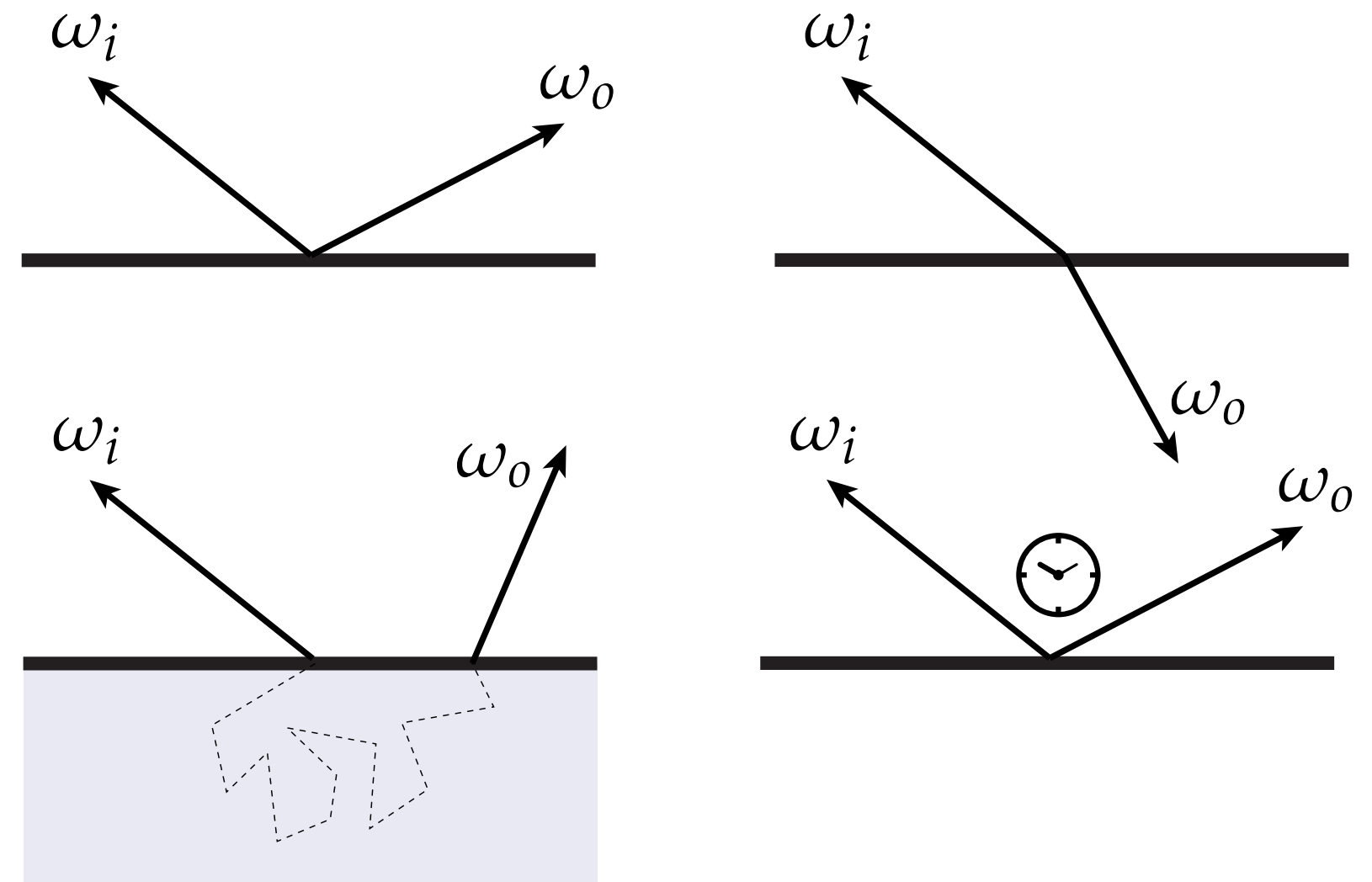

- What goes in must come out! (Total energy must be conserved)
- In general, can talk about “probability*” a particle arriving from a given direction is scattered in another direction

*Somewhat more complicated than this, because some light is absorbed!

Hemispherical incident radiance

At any point on any surface in the scene, there's an incident radiance field that gives the directional distribution of illumination at the point

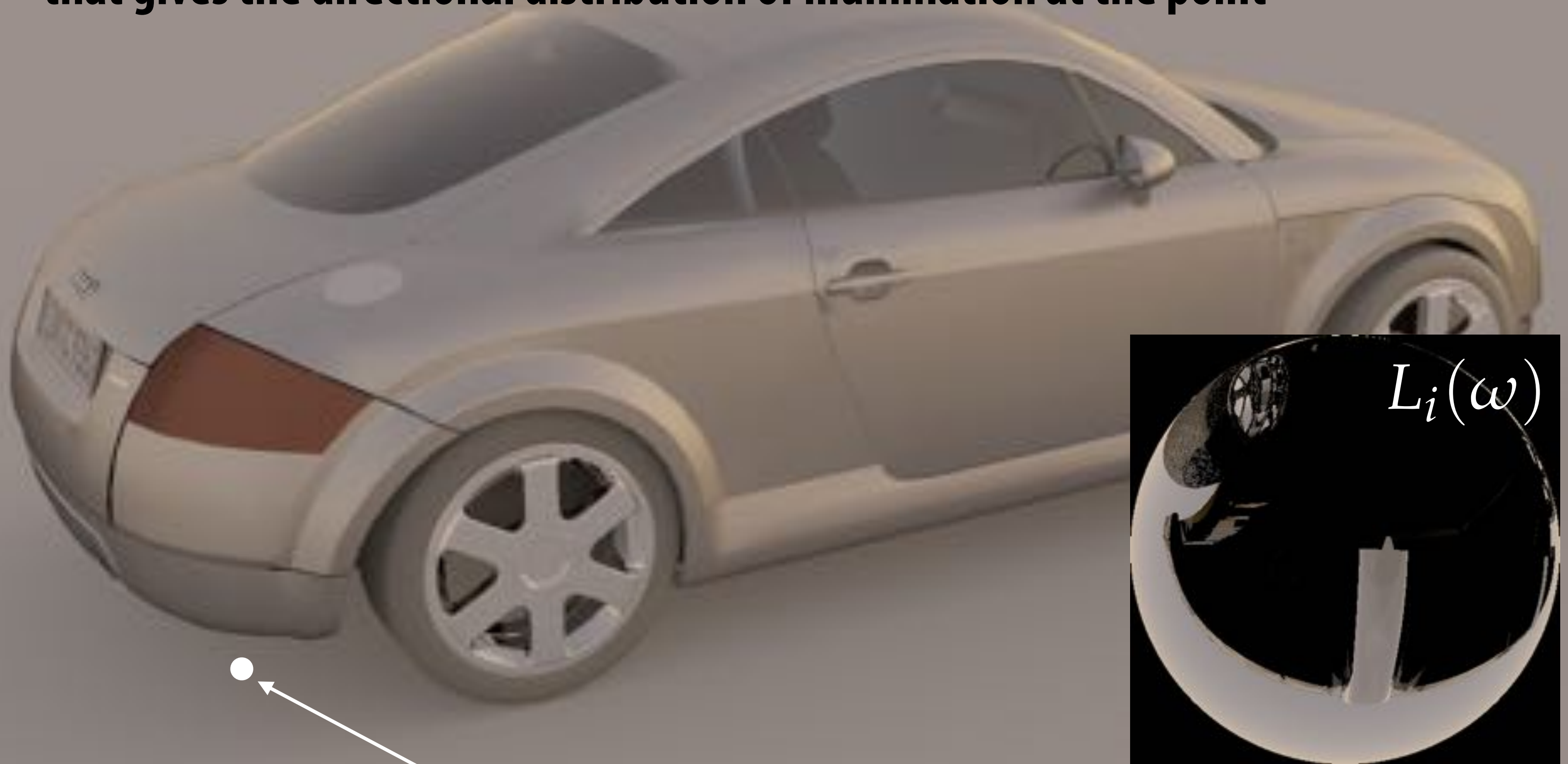

Consider view of hemisphere from this point

Diffuse reflection

Exitant radiance is the same in all directions



Incident radiance



Exitant radiance

Ideal specular reflection

Incident radiance is “flipped around normal” to get exitant radiance



Incident radiance



Exitant radiance

Plastic

Incident radiance gets “flipped and blurred”



Incident radiance



Exitant radiance

Copper

More blurring, plus coloration (nonuniform absorption across frequencies)



Incident radiance



Exitant radiance

Scattering off a surface: the BRDF

- “Bidirectional reflectance distribution function”
- Encodes behavior of light that “bounces off” surface
- Given incoming direction ω_i , how much light gets scattered in any given outgoing direction ω_o ?
- Describe as distribution $f_r(\omega_i \rightarrow \omega_o)$

$$f_r(\omega_i \rightarrow \omega_o) \geq 0$$

why less than or equal?

$$\int_{\mathcal{H}^2} f_r(\omega_i \rightarrow \omega_o) \cos \theta \, d\omega_i \leq 1$$

where did the rest of the energy go?!

$$f_r(\omega_i \rightarrow \omega_o) = f_r(\omega_o \rightarrow \omega_i)$$

“Helmholtz reciprocity”

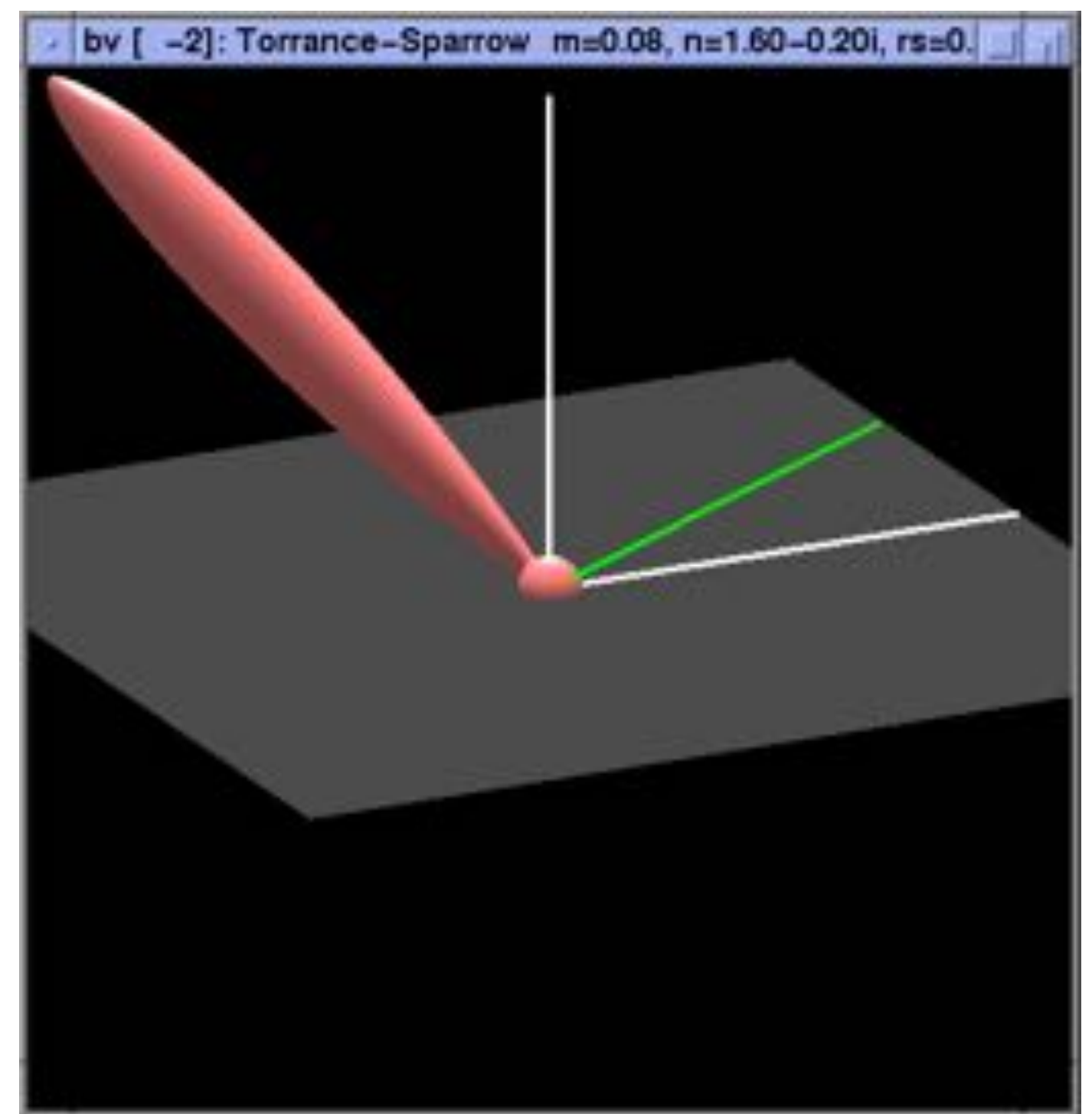

bv (Szymon Rusinkiewicz)

Q: Why should Helmholtz reciprocity hold? Think about little mirrors...

Radiometric description of BRDF

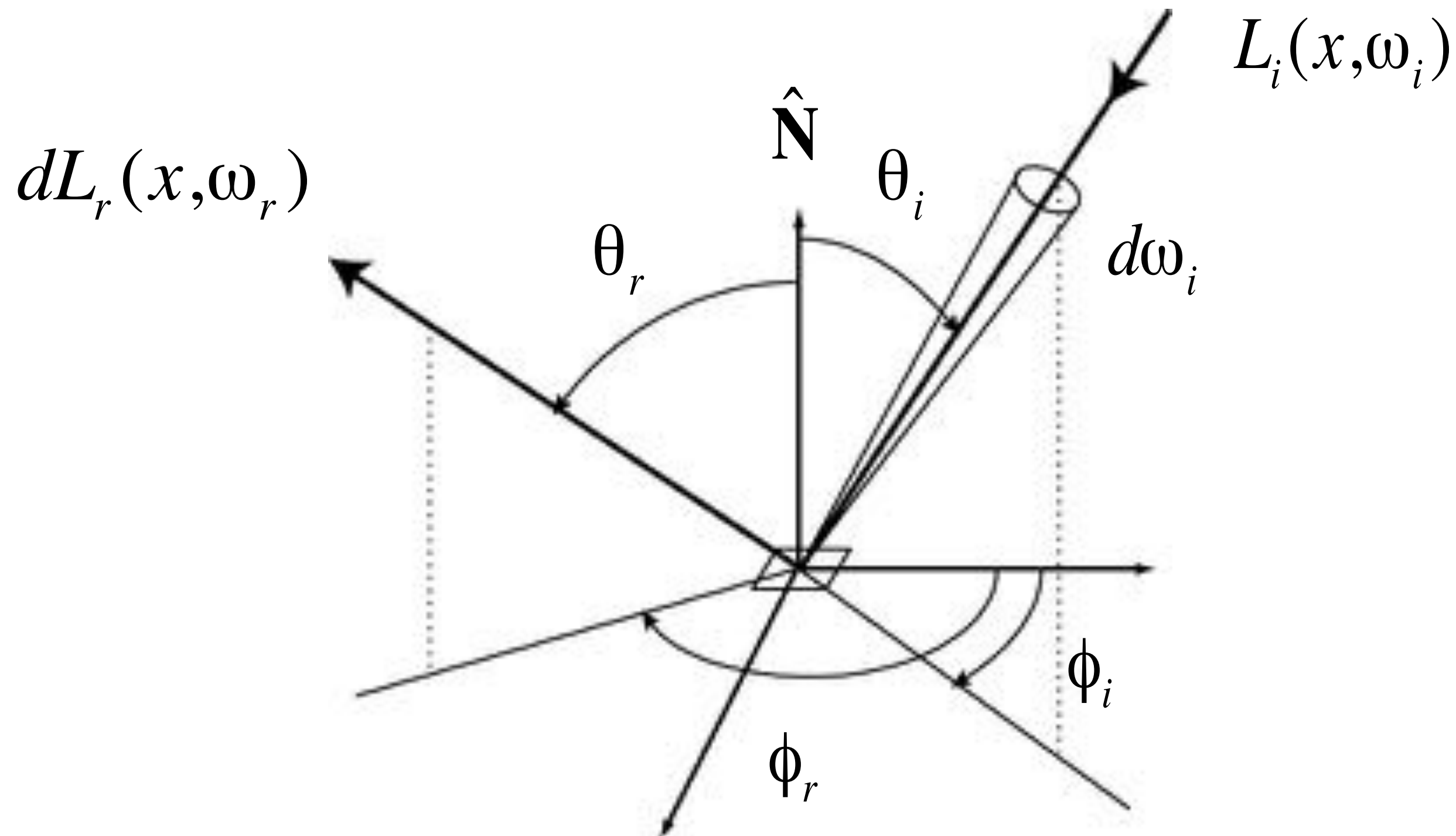

$$f_r(\omega_i \rightarrow \omega_o) = \frac{dL_o(\omega_o)}{dE_i(\omega_i)} = \frac{dL_o(\omega_o)}{dL_i(\omega_i) \cos \theta_i} \left[\frac{1}{sr} \right]$$

“For a given change in the incident irradiance, how much does the exitant radiance change?”

Example: Lambertian reflection

Assume light is equally likely to be reflected in each output direction

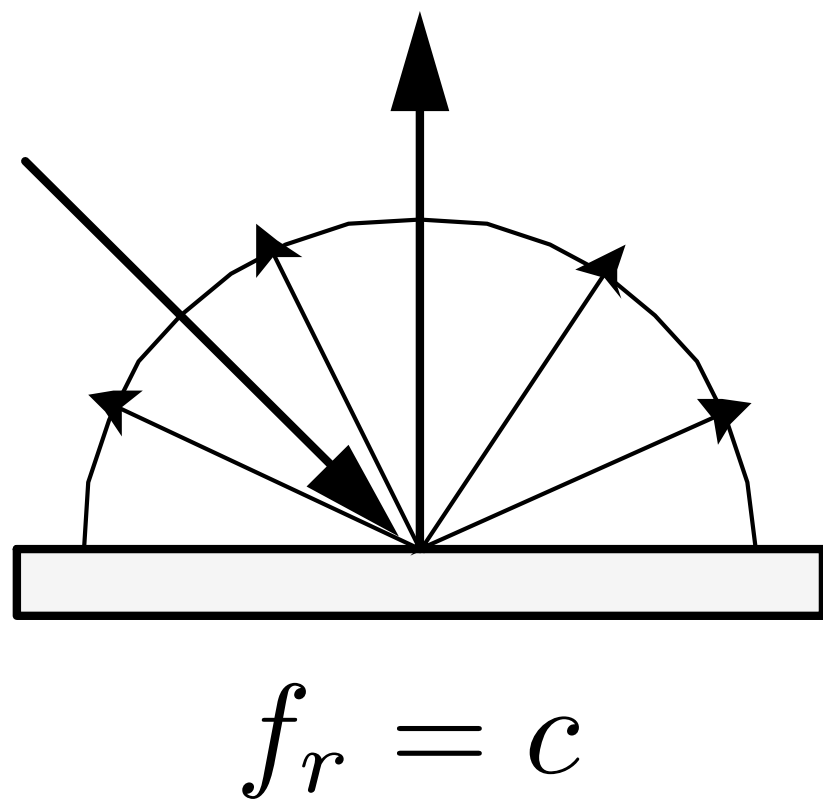

$$\begin{aligned} L_o(\omega_o) &= \int_{H^2} f_r L_i(\omega_i) \cos \theta_i d\omega_i \\ &= f_r \int_{H^2} L_i(\omega_i) \cos \theta_i d\omega_i \\ &= f_r E \end{aligned}$$

“albedo” (between 0 and 1)

$$f_r = \frac{\rho}{\pi}$$



Example: perfect specular reflection

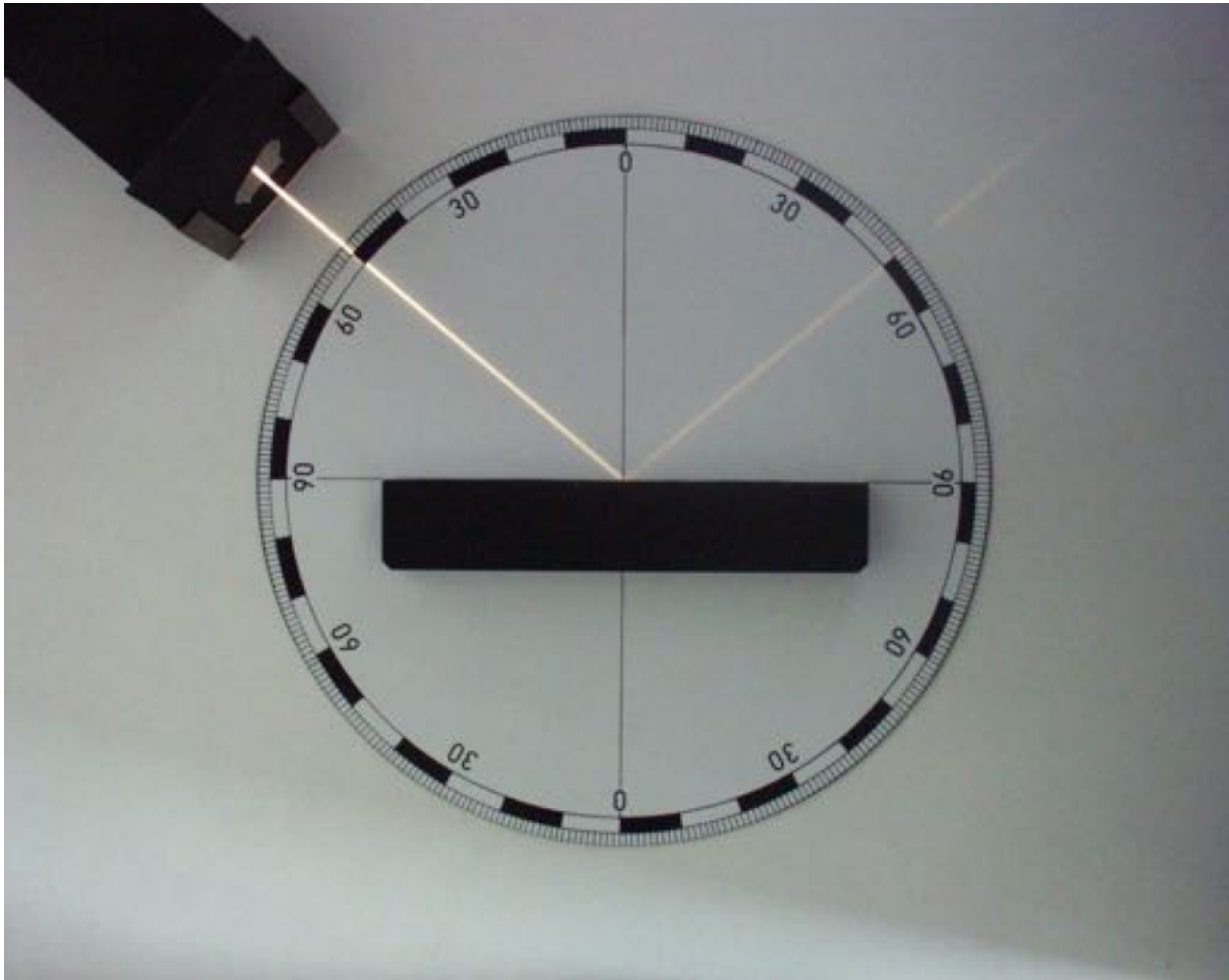

[Zátonyi Sándor]

Geometry of specular reflection

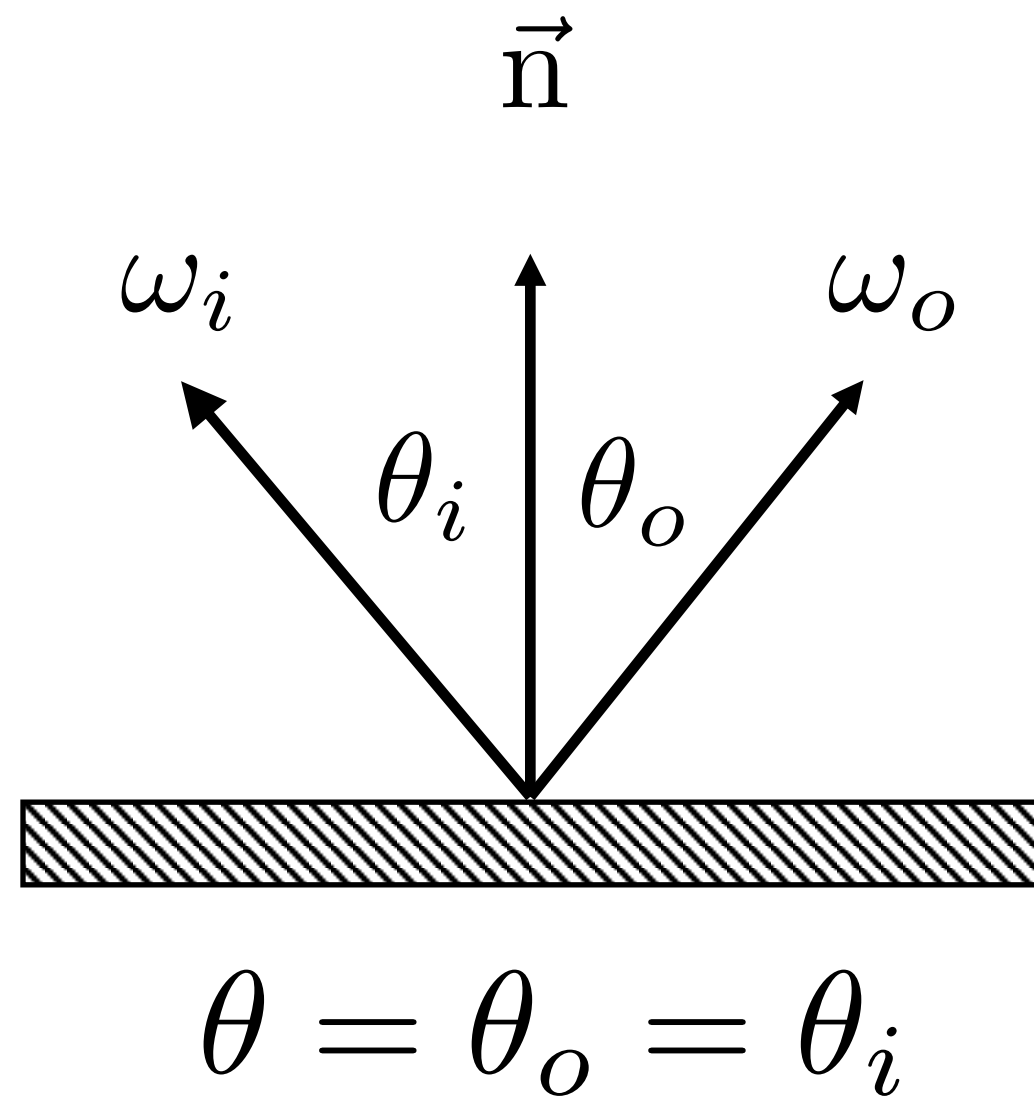

Top-down view
(looking down on surface)

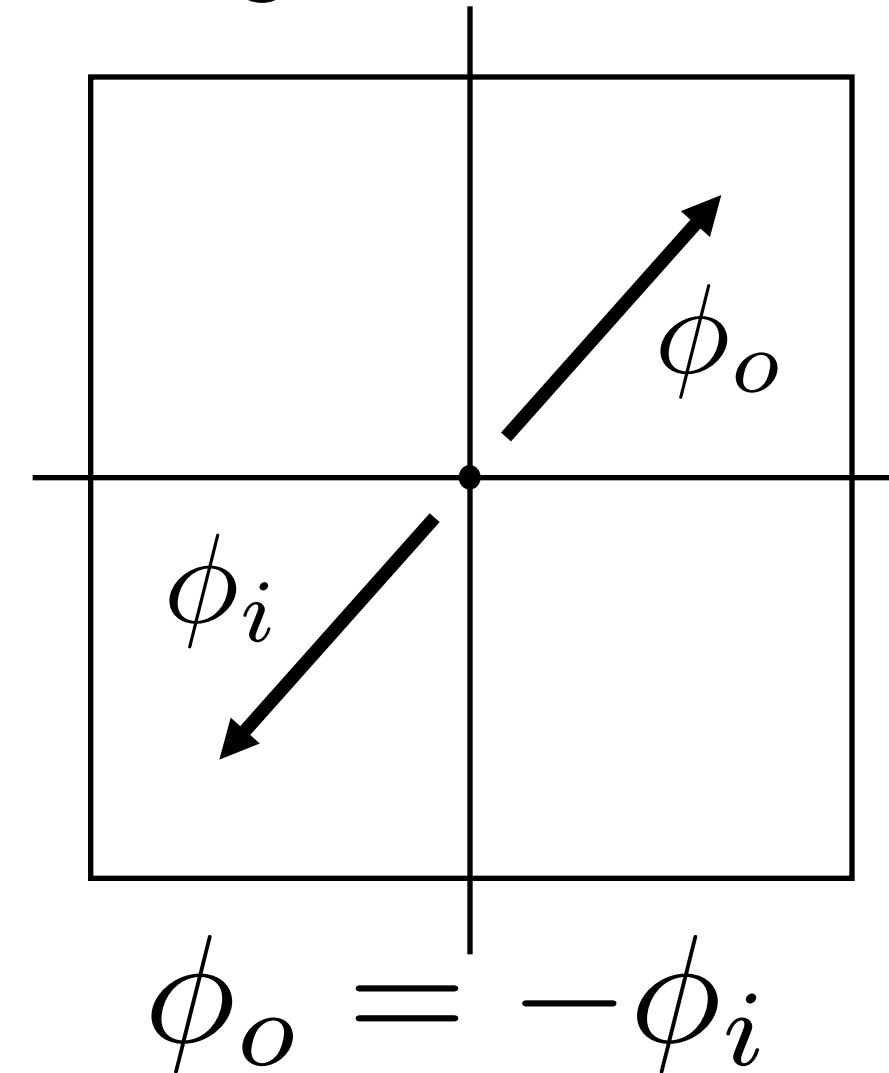

$$\omega_o = -\omega_i + 2(\omega_i \cdot \vec{n})\vec{n}$$

Specular reflection BRDF

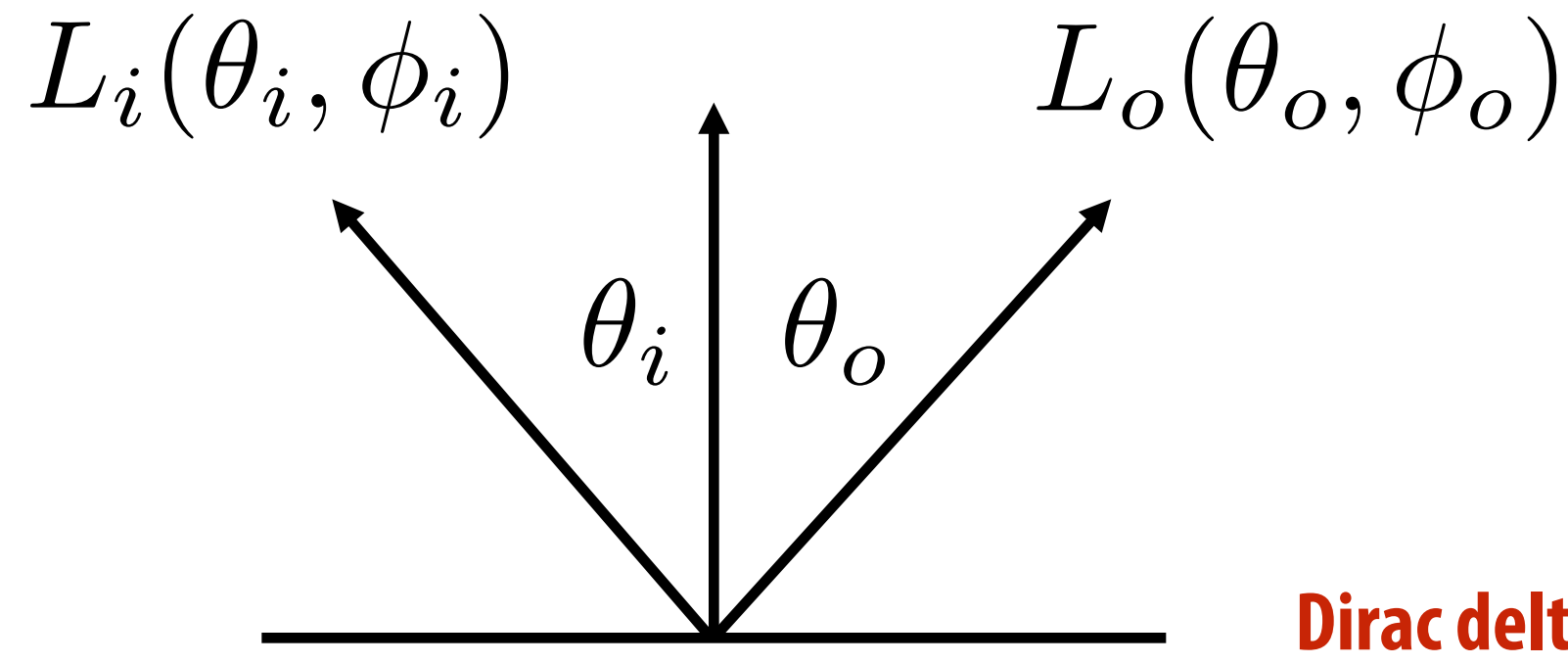

$$L_o(\theta_o, \phi_o) = L_i(\theta_i, \phi_i)$$

$$f_r(\theta_i, \phi_i; \theta_o, \phi_o) = \frac{\delta(\cos \theta_i - \cos \theta_o)}{\cos \theta_i} \delta(\phi_i - \phi_o \pm \pi)$$

Dirac delta

- **Strictly speaking, f_r is a distribution, not a function**
- **In practice, no hope of finding reflected direction via random sampling; simply pick the reflected direction!**



Transmission

In addition to reflecting off surface, light may be transmitted through surface.

Light refracts when it enters a new medium.

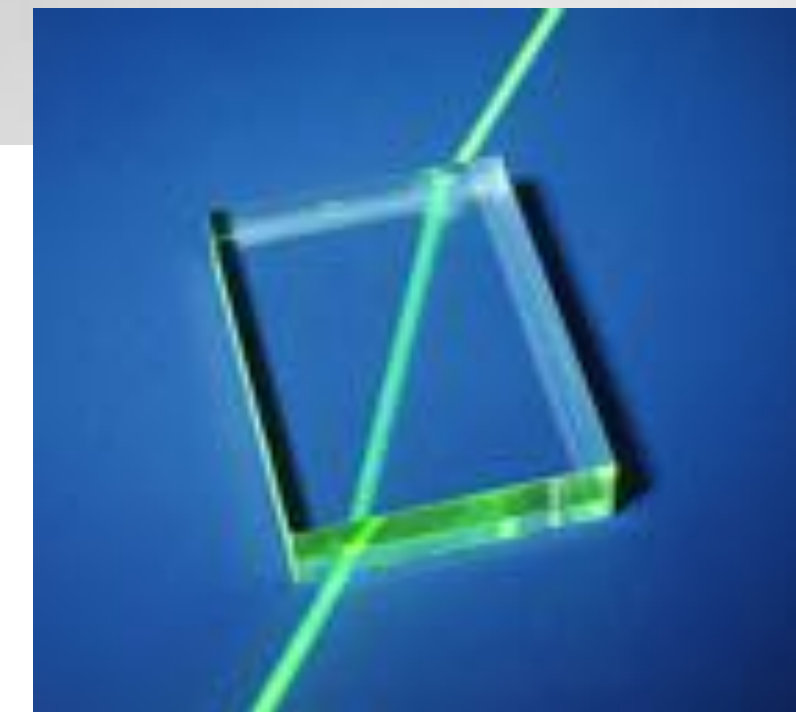
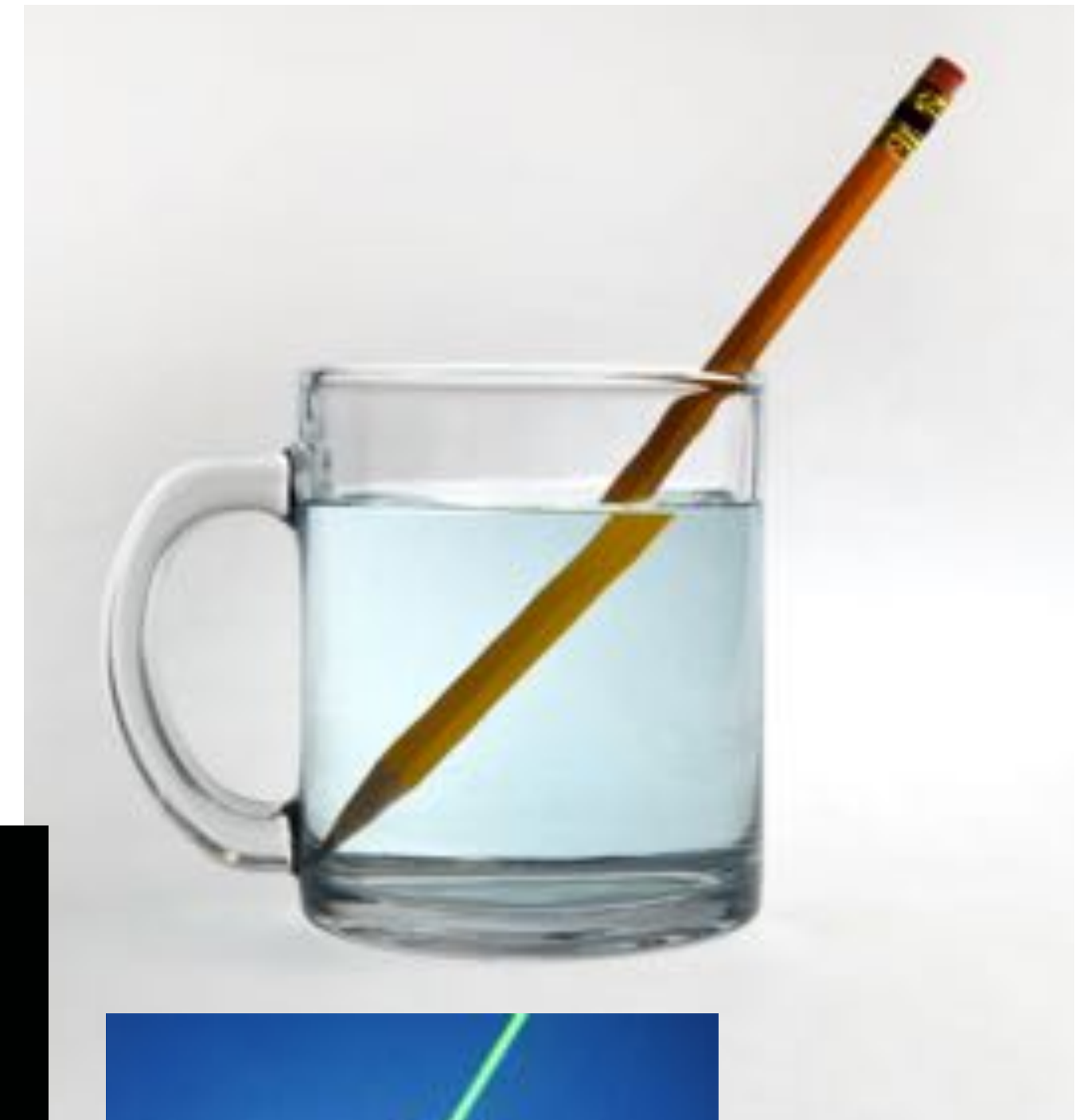

Snell's Law

Transmitted angle depends on relative index of refraction of material ray is leaving/entering.

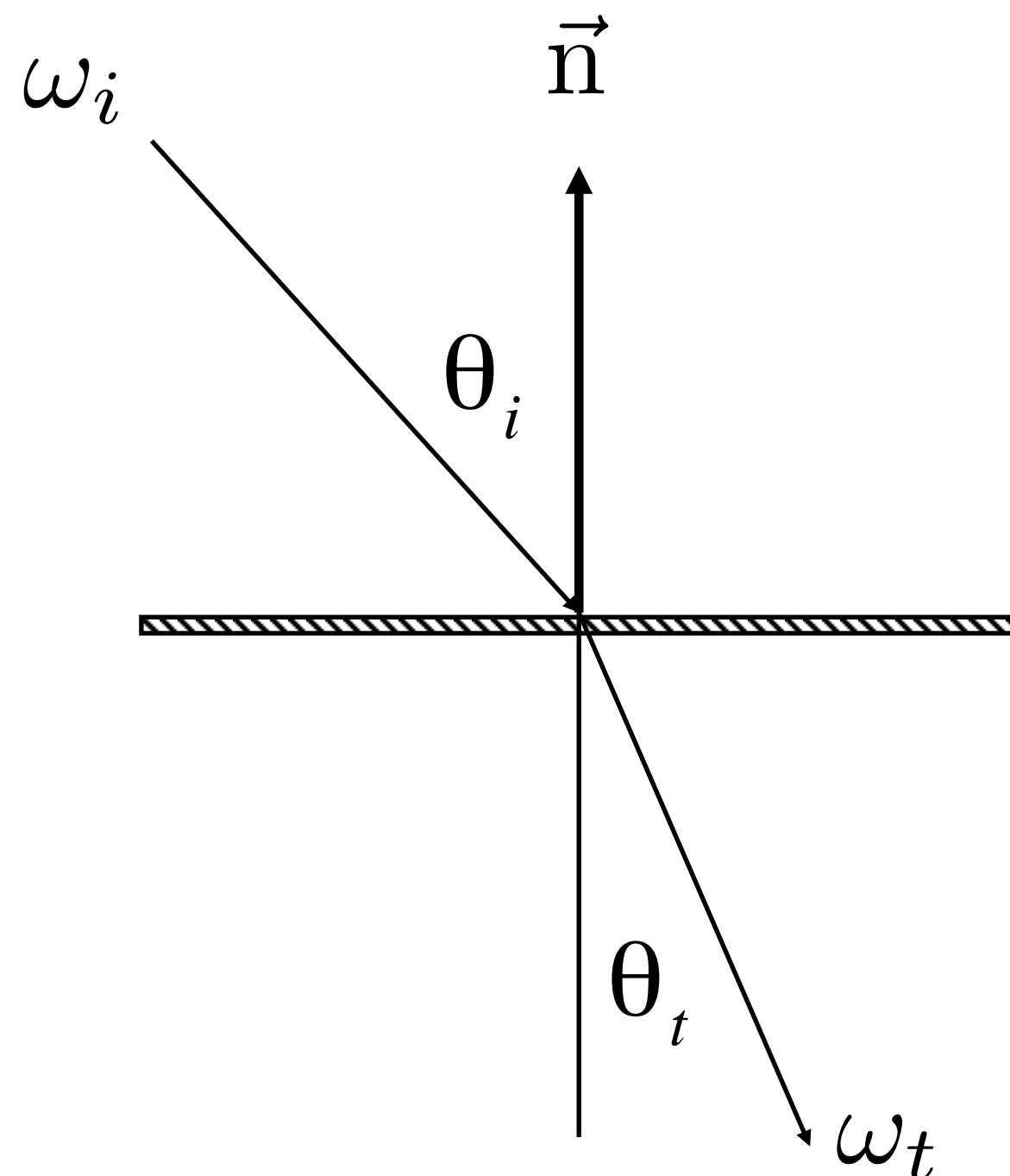

$$\eta_i \sin \theta_i = \eta_t \sin \theta_t$$

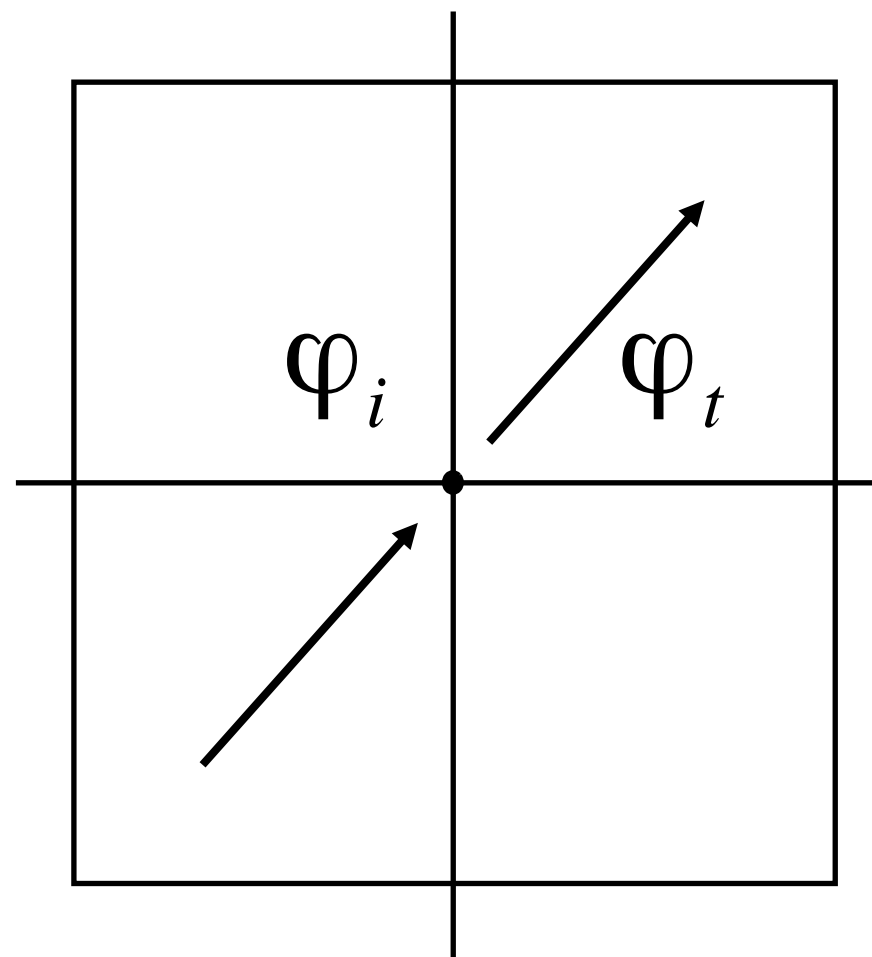

Medium	η^*
Vacuum	1.0
Air (sea level)	1.00029
Water (20°C)	1.333
Glass	1.5-1.6
Diamond	2.42

* index of refraction is wavelength dependent (these are averages)

Law of refraction

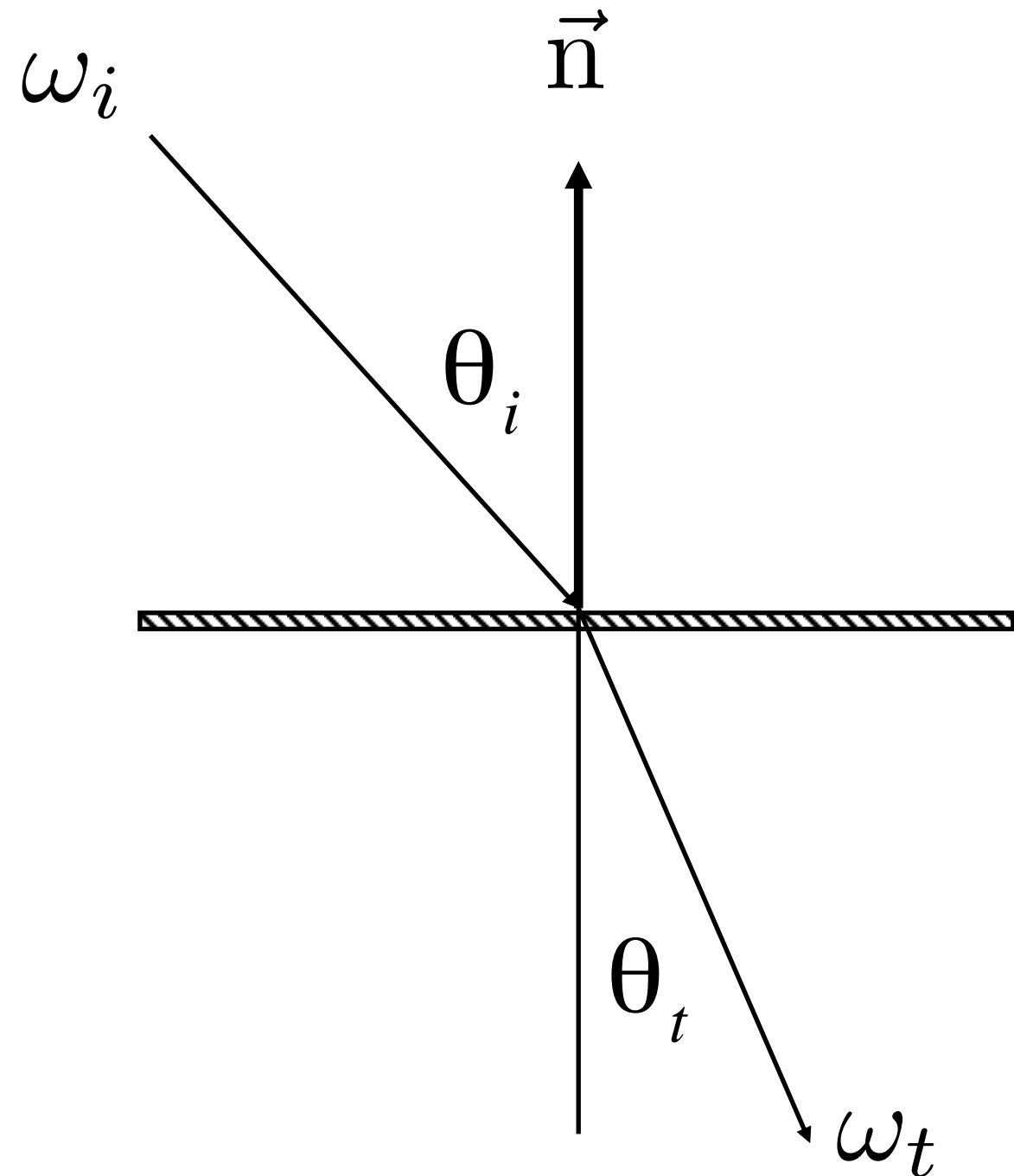

$$\eta_i \sin \theta_i = \eta_t \sin \theta_t$$

$$\cos \theta_t = \sqrt{1 - \sin^2 \theta_t}$$

$$= \sqrt{1 - \left(\frac{\eta_i}{\eta_t}\right)^2 \sin^2 \theta_i}$$

$$= \sqrt{1 - \left(\frac{\eta_i}{\eta_t}\right)^2 (1 - \cos^2 \theta_i)}$$

$$1 - \left(\frac{\eta_i}{\eta_t}\right)^2 (1 - \cos^2 \theta_i) < 0$$

Total internal reflection:

When light is moving from a more optically dense medium to a less optically dense medium: $\frac{\eta_i}{\eta_t} > 1$

Light incident on boundary from large enough angle will not exit medium.

Optical manhole

Only small "cone" visible, due to total internal reflection (TIR)

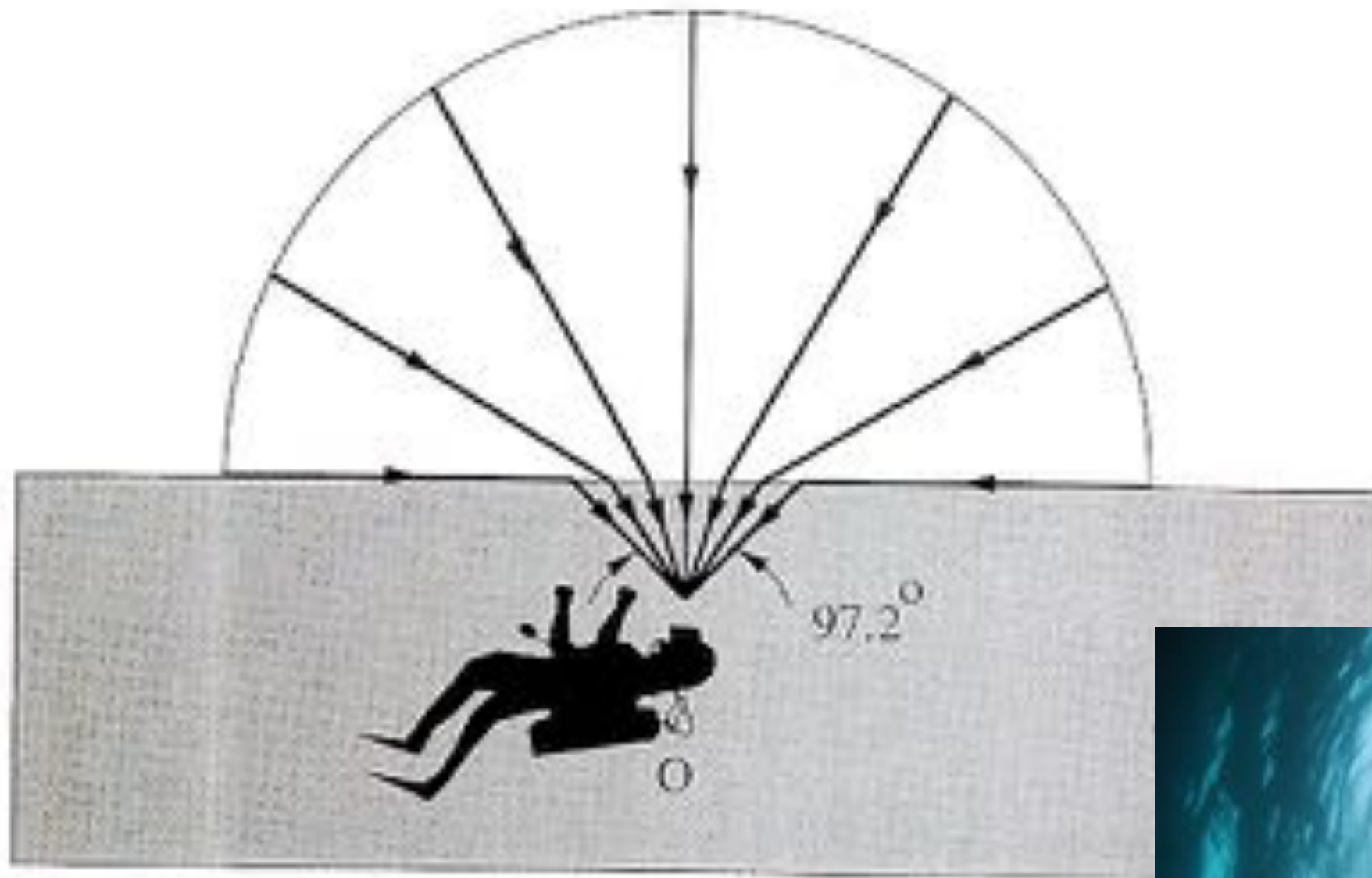

Fresnel reflection

Many real materials:
reflectance increases w/
viewing angle

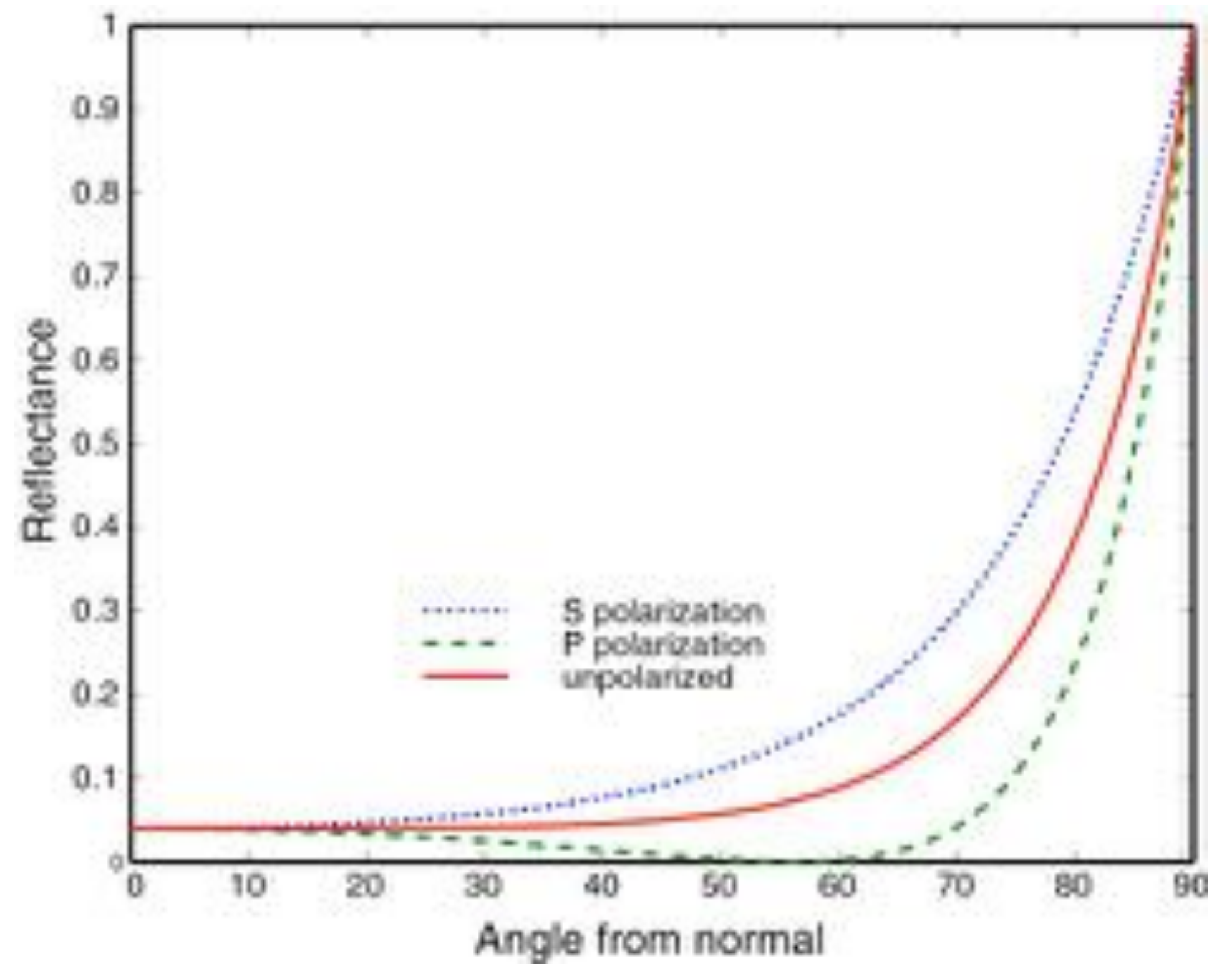

[Lafortune et al. 1997]

Snell + Fresnel: Example



Reflection (Fresnel)

Refraction (Snell)

Without Fresnel (fixed reflectance/transmission)

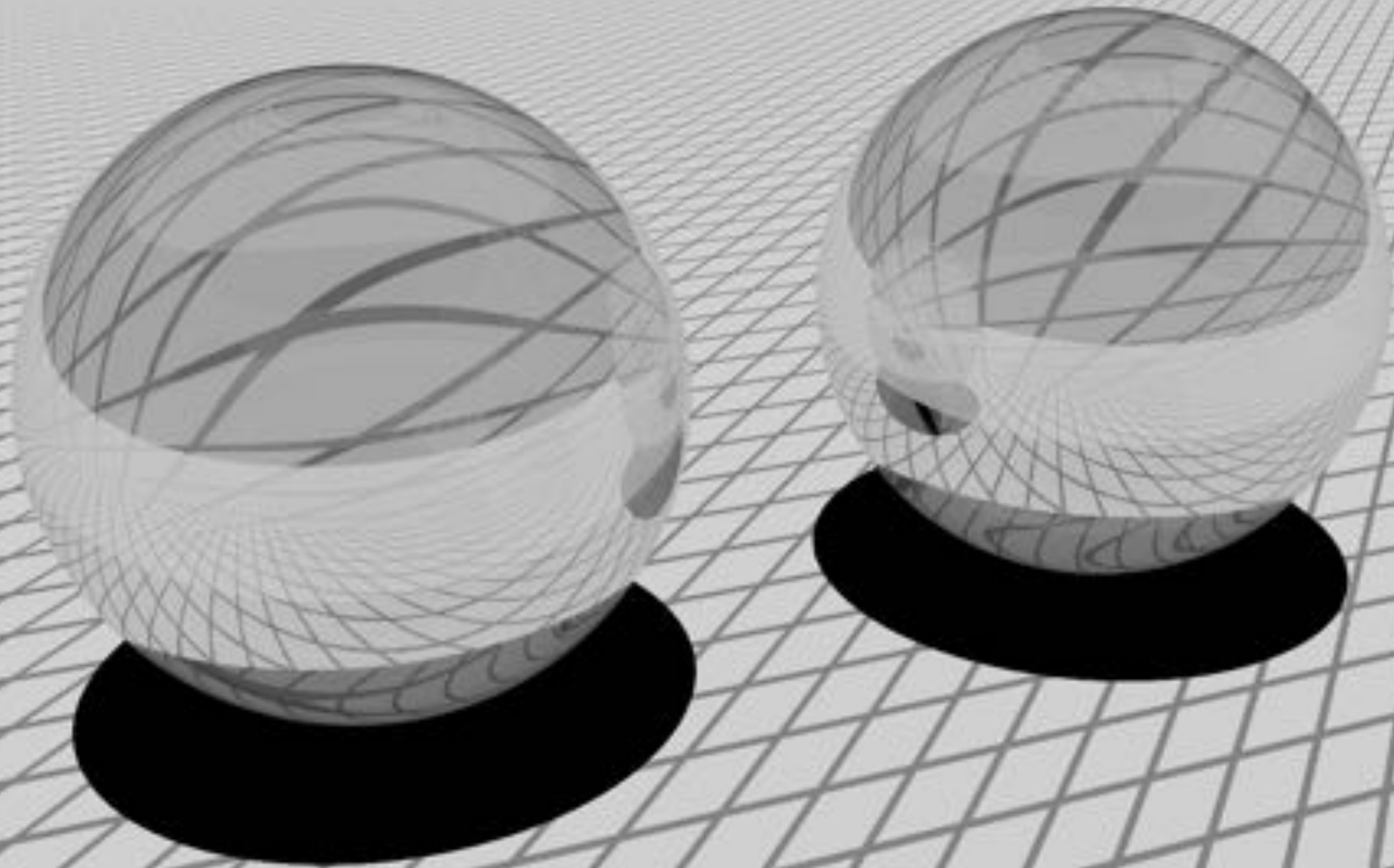

Glass with Fresnel reflection/transmission

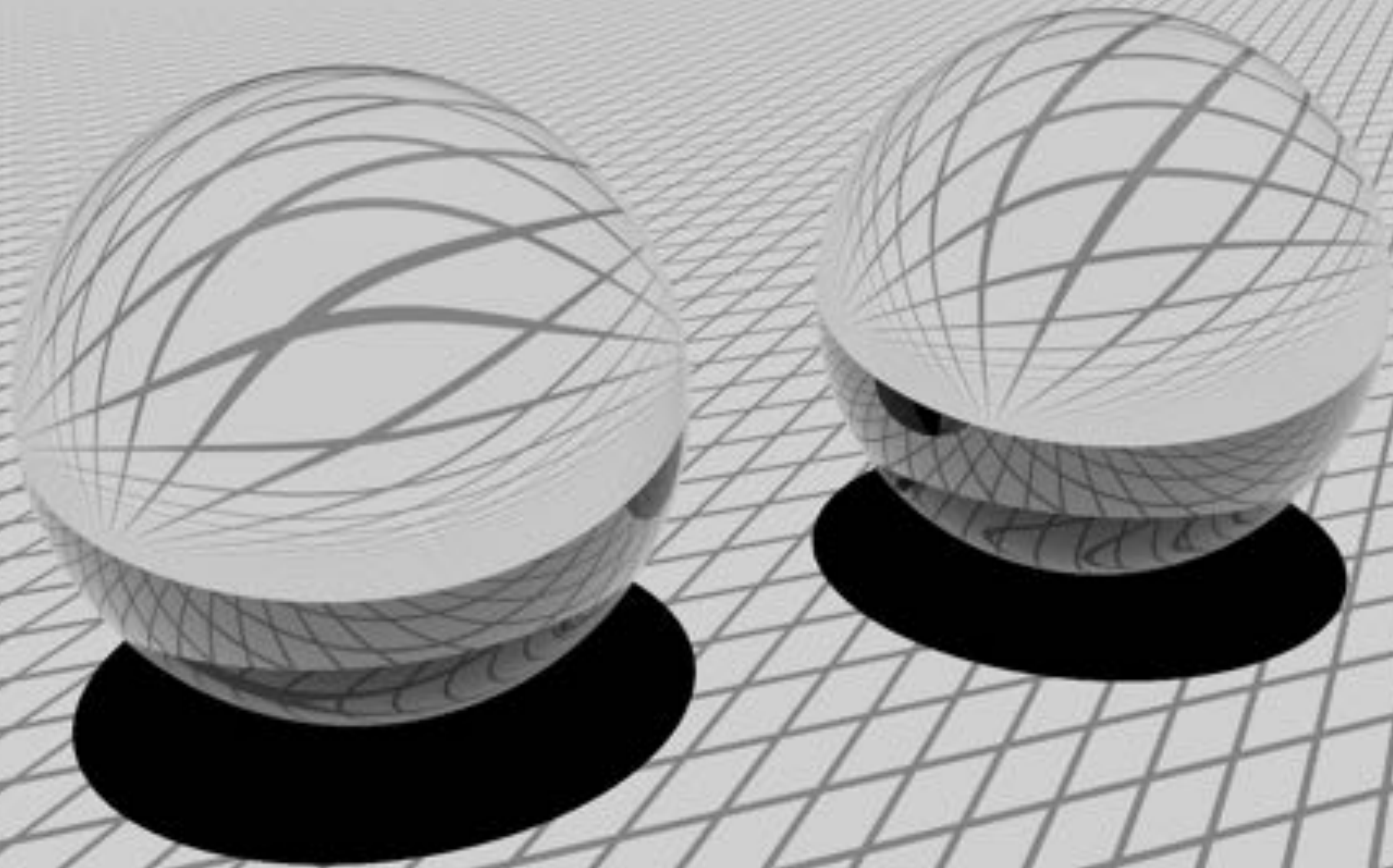

Anisotropic reflection

Reflection depends on azimuthal angle ϕ



Results from oriented microstructure of surface
e.g., brushed metal

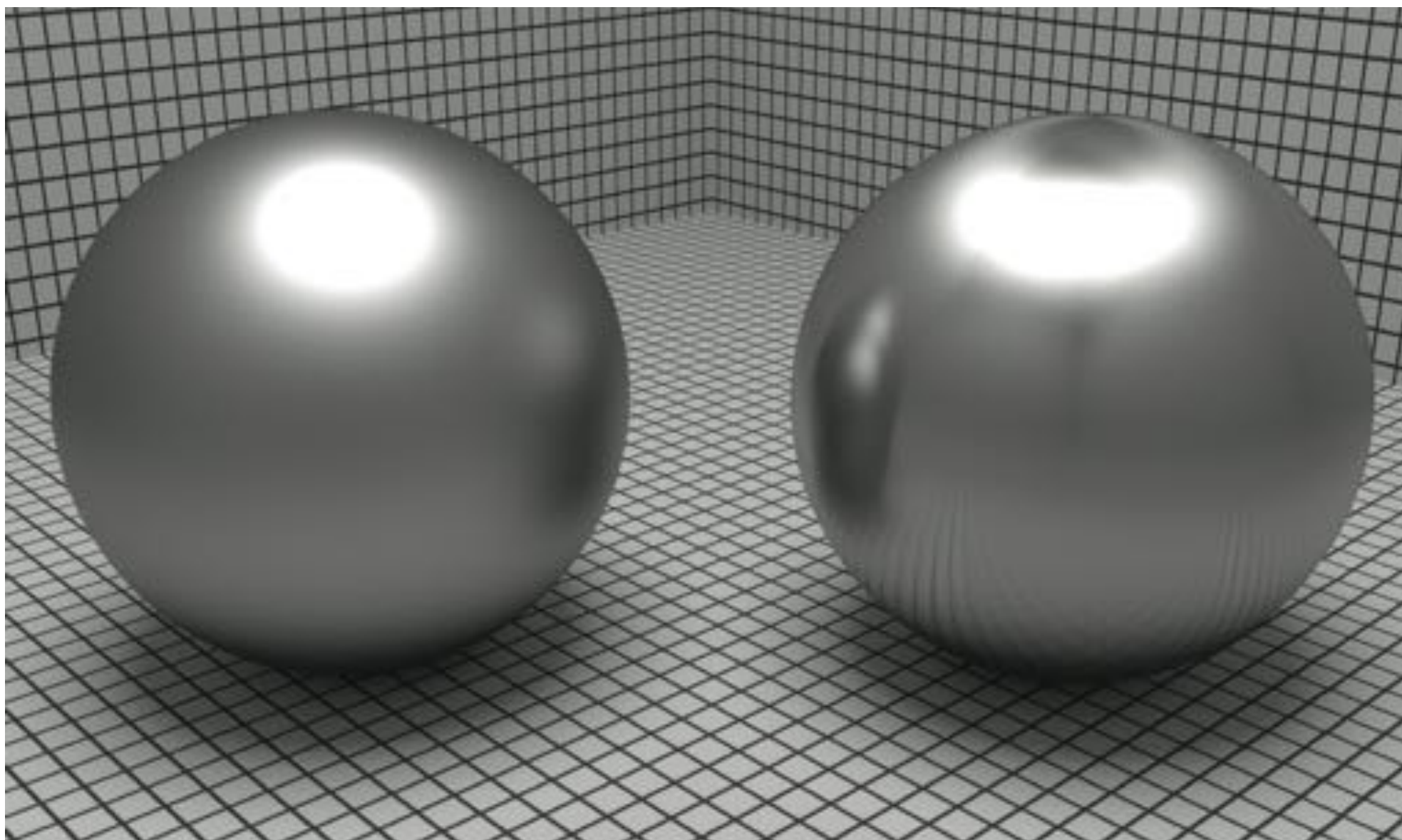

Translucent materials: Jade



Translucent materials: skin



Translucent materials: leaves



Subsurface scattering

- **Visual characteristics of many surfaces caused by light entering at different points than it exits**
 - **Violates a fundamental assumption of the BRDF**
 - **Need to generalize scattering model (BSSRDF)**

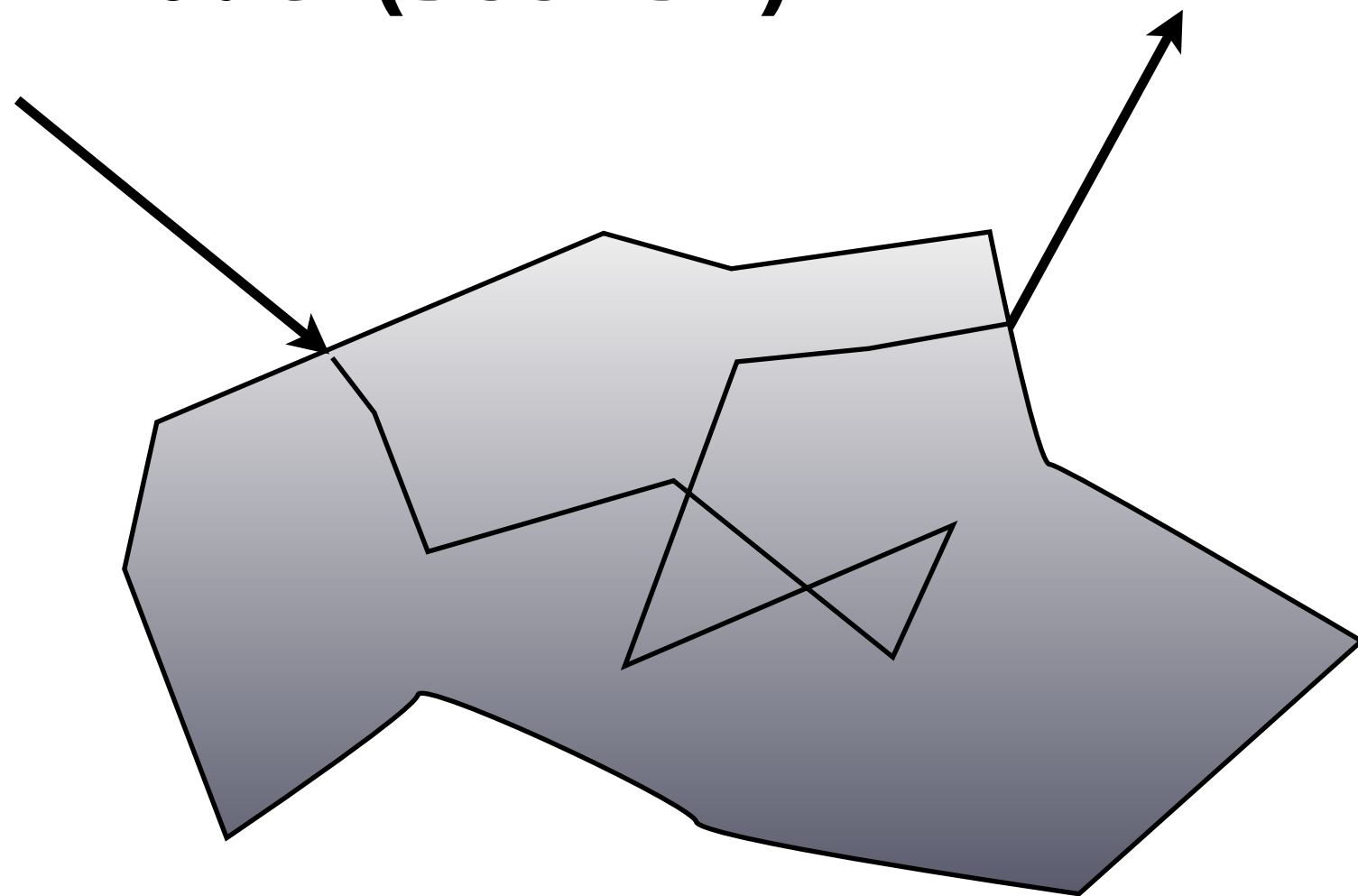

[Jensen et al 2001]

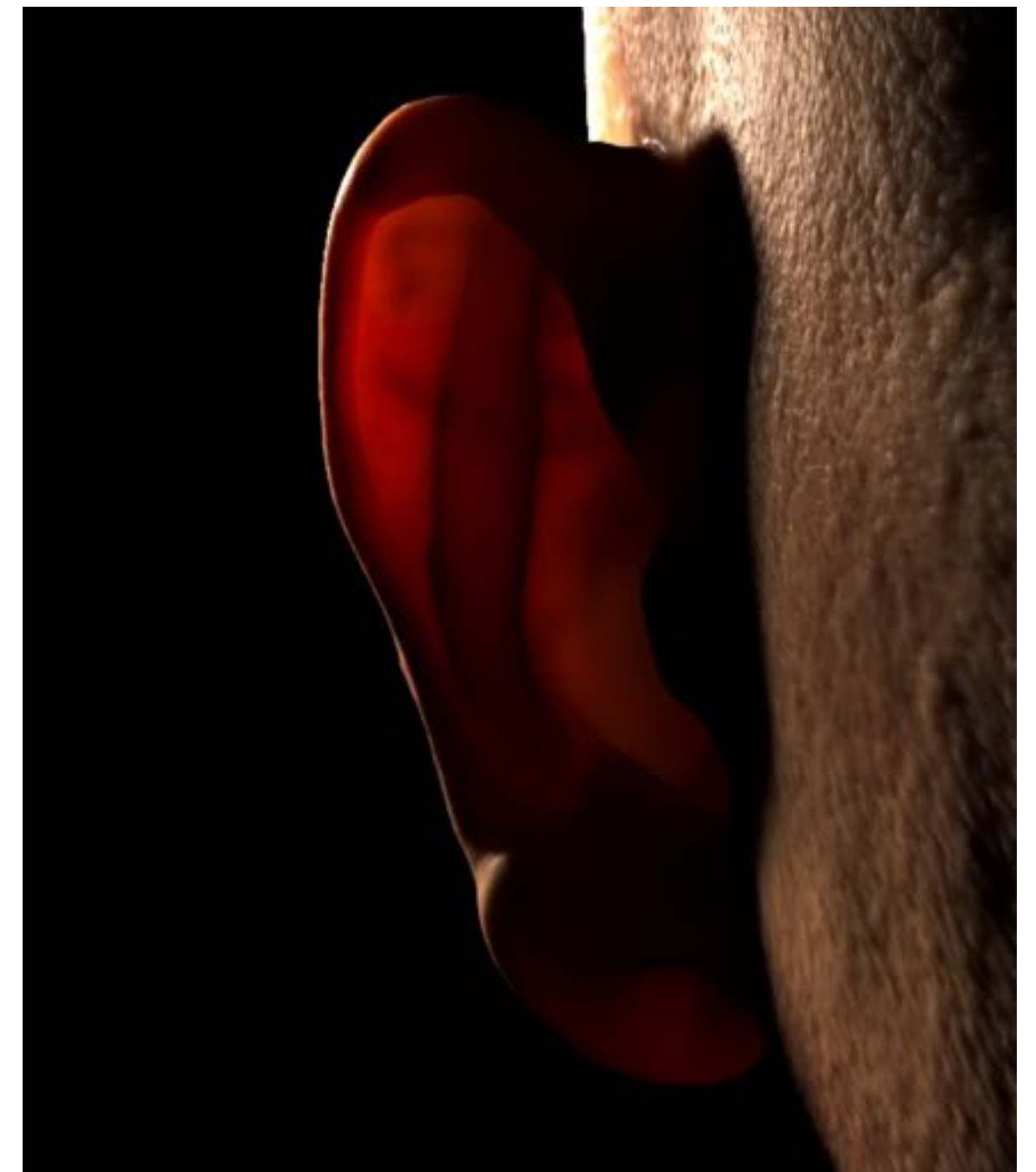

[Donner et al 2008]

Scattering functions

- **Generalization of BRDF; describes exitant radiance at one point due to incident differential irradiance at another point:**

$$S(x_i, \omega_i, x_o, \omega_o)$$

- **Generalization of reflection equation integrates over all points on the surface and all directions(!)**

$$L(x_o, \omega_o) = \int_A \int_{H^2} S(x_i, \omega_i, x_o, \omega_o) L_i(x_i, \omega_i) \cos \theta_i d\omega_i dA$$

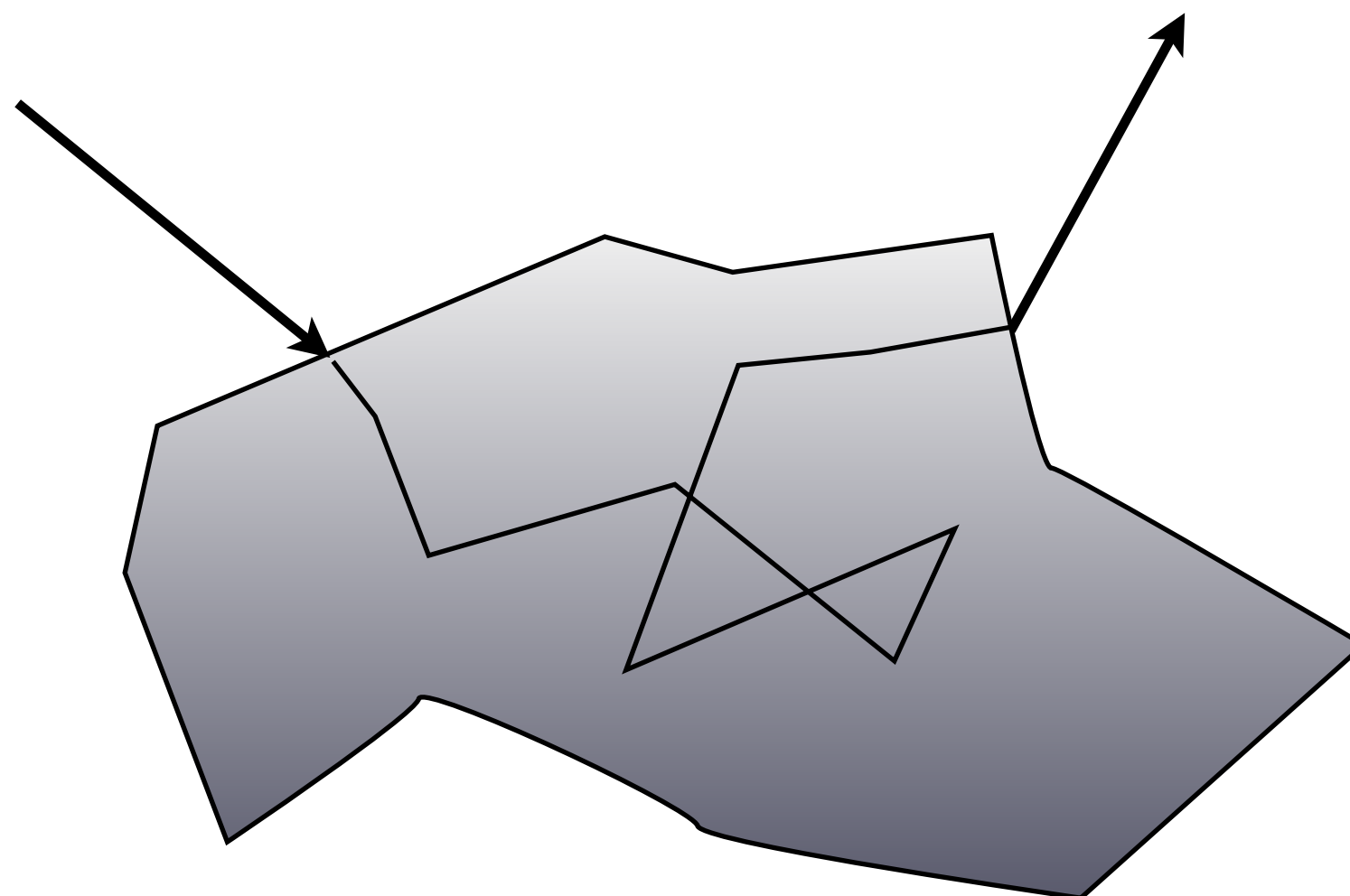

BRDF



BSSRDF



Ok, so scattering is complicated!

**What's a (relatively simple) algorithm
that can capture all this behavior?**

**We start by returning to reflection
without scattering (using the BRDF)**

The reflection equation

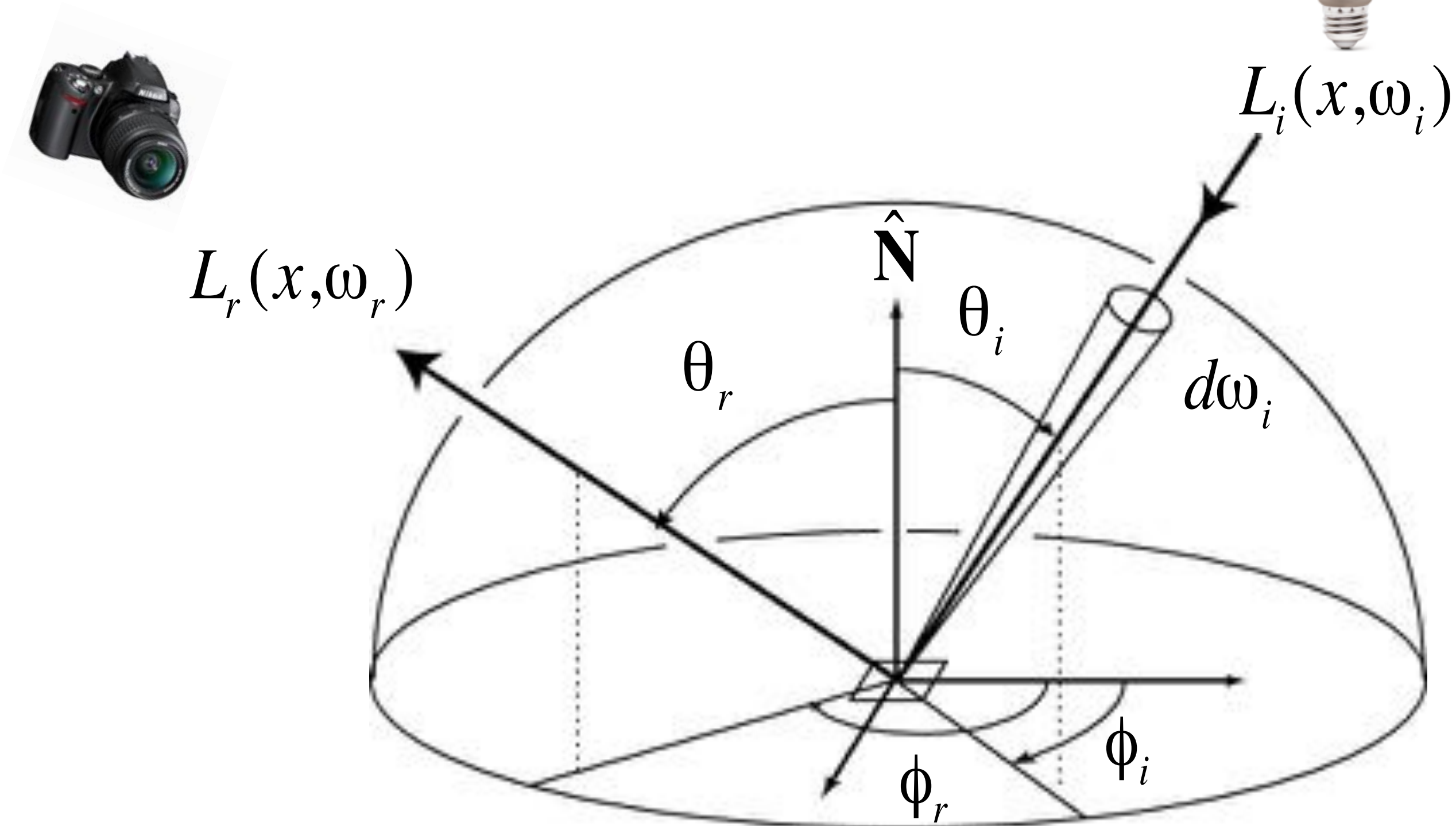

$$dL_r(\omega_r) = f_r(\omega_i \rightarrow \omega_r) dL_i(\omega_i) \cos \theta_i$$

$$L_r(p, \omega_r) = \int_{H^2} f_r(p, \omega_i \rightarrow \omega_r) L_i(p, \omega_i) \cos \theta_i d\omega_i$$

The reflection equation

- Key piece of overall rendering equation:

$$L_r(p, \omega_r) = \int_{H^2} f_r(p, \omega_i \rightarrow \omega_r) L_i(p, \omega_i) \cos \theta_i d\omega_i$$

- Approximate integral via Monte Carlo integration
- Generate directions ω_j sampled from some distribution $p(\omega)$
- Compute the estimator

$$\frac{1}{N} \sum_{j=1}^N \frac{f_r(p, \omega_j \rightarrow \omega_r) L_i(p, \omega_j) \cos \theta_j}{p(\omega_j)}$$

- To reduce variance $p(\omega)$ should match BRDF or incident radiance function

Estimating reflected light

```
// Assume:  
// Ray ray hits surface at point hit_p  
// Normal of surface at hit point is hit_n  
  
Vector3D wr = -ray.d; // outgoing direction  
Spectrum Lr = 0.;  
for (int i = 0; i < N; ++i) {  
    Vector3D wi; // sample incident light from this direction  
    float pdf; // p(wi)  
  
    generate_sample(brdf, &wi, &pdf); // generate sample according to brdf  
  
    Spectrum f = brdf->f(wr, wi);  
    Spectrum Li = trace_ray(Ray(hit_p, wi)); // compute incoming Li  
    Lr += f * Li * fabs(dot(wi, hit_n)) / pdf;  
}  
return Lr / N;
```

The rendering equation

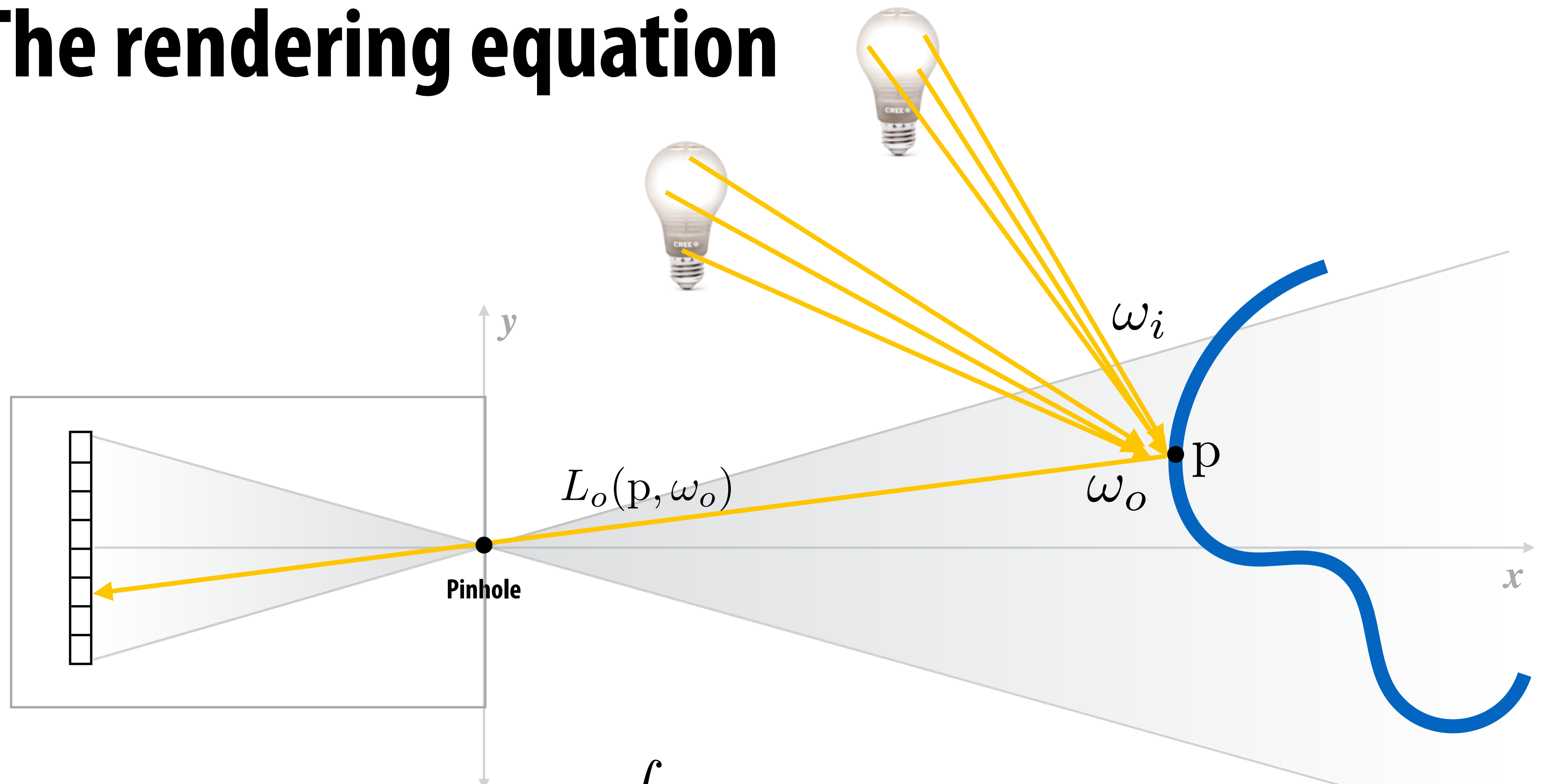

$$L_o(p, \omega_o) = L_e(p, \omega_o) + \int_{H^2} f_r(p, \omega_i \rightarrow \omega_o) L_i(p, \omega_i) \cos \theta_i d\omega_i$$

Now that we know how to handle reflection, how do we solve the full rendering equation? Have to determine incident radiance...

Key idea in (efficient) rendering: take advantage of special knowledge to break up integration into “easier” components.

Path tracing: overview

- Partition the rendering equation into direct and indirect illumination
- Use Monte Carlo to estimate each partition separately
 - One sample for each
 - Assumption: 100s of samples per pixel
- Terminate paths with Russian roulette

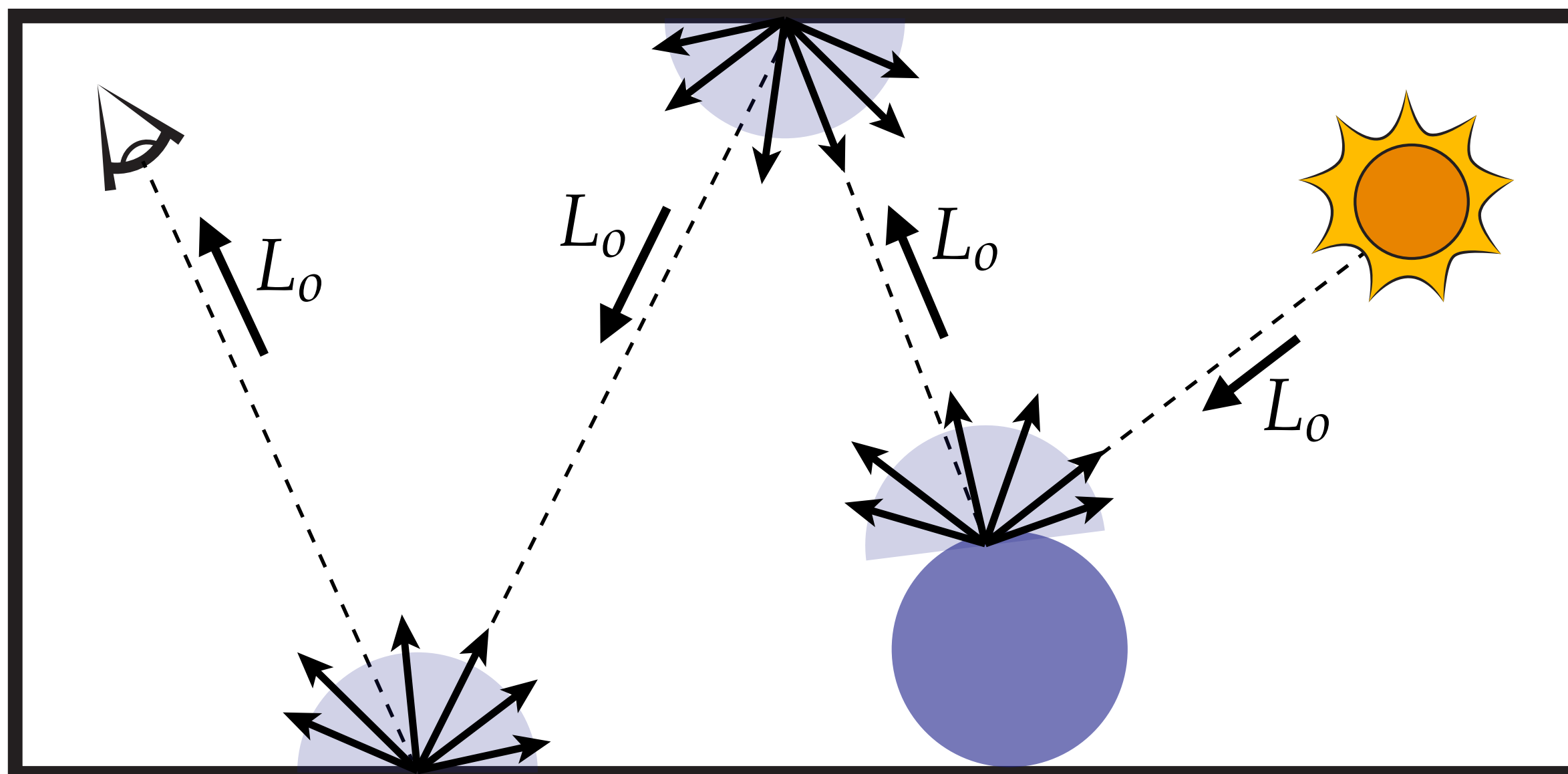

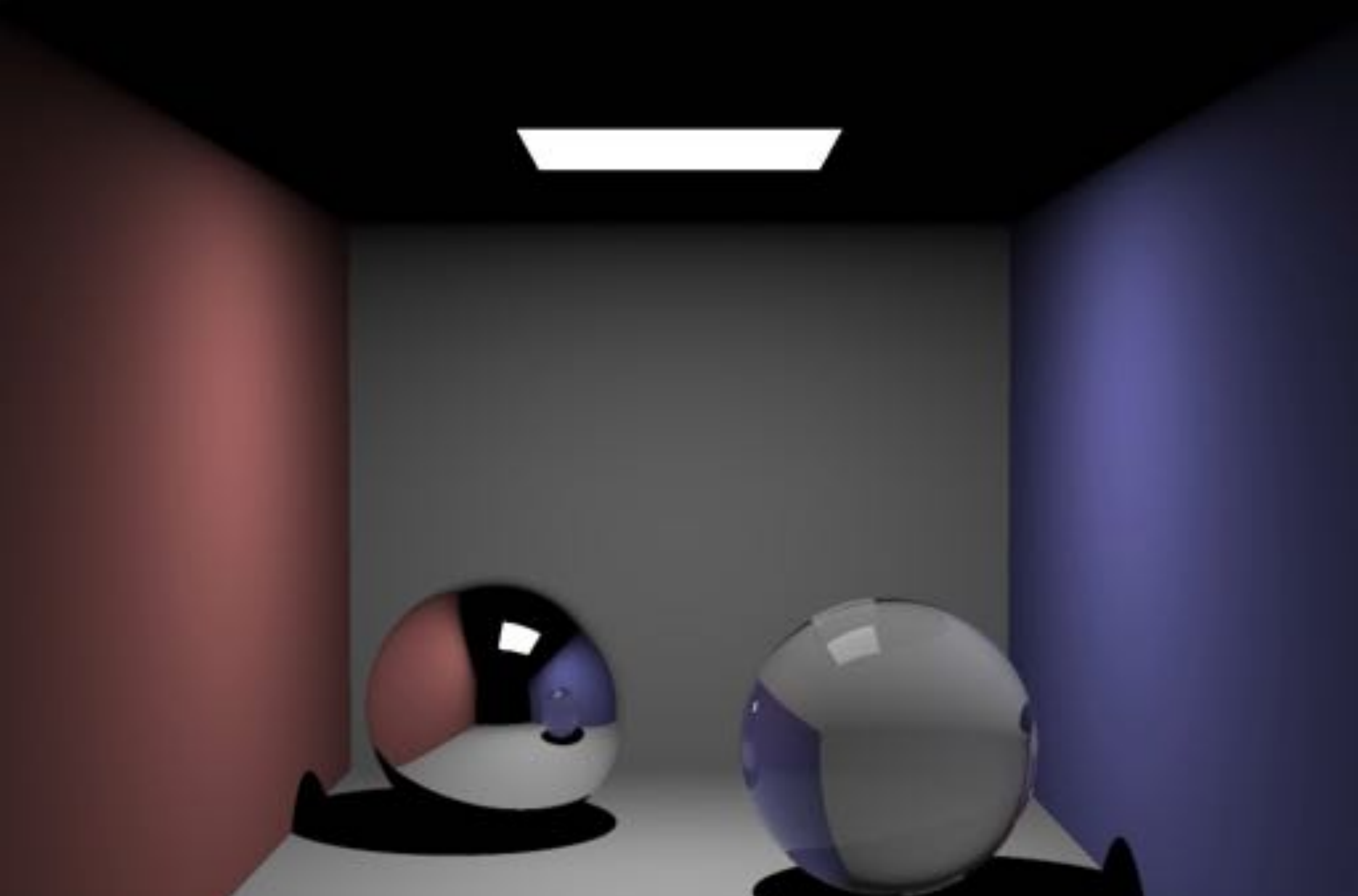

Direct illumination + reflection + transparency

Image credit: Henrik Wann Jensen

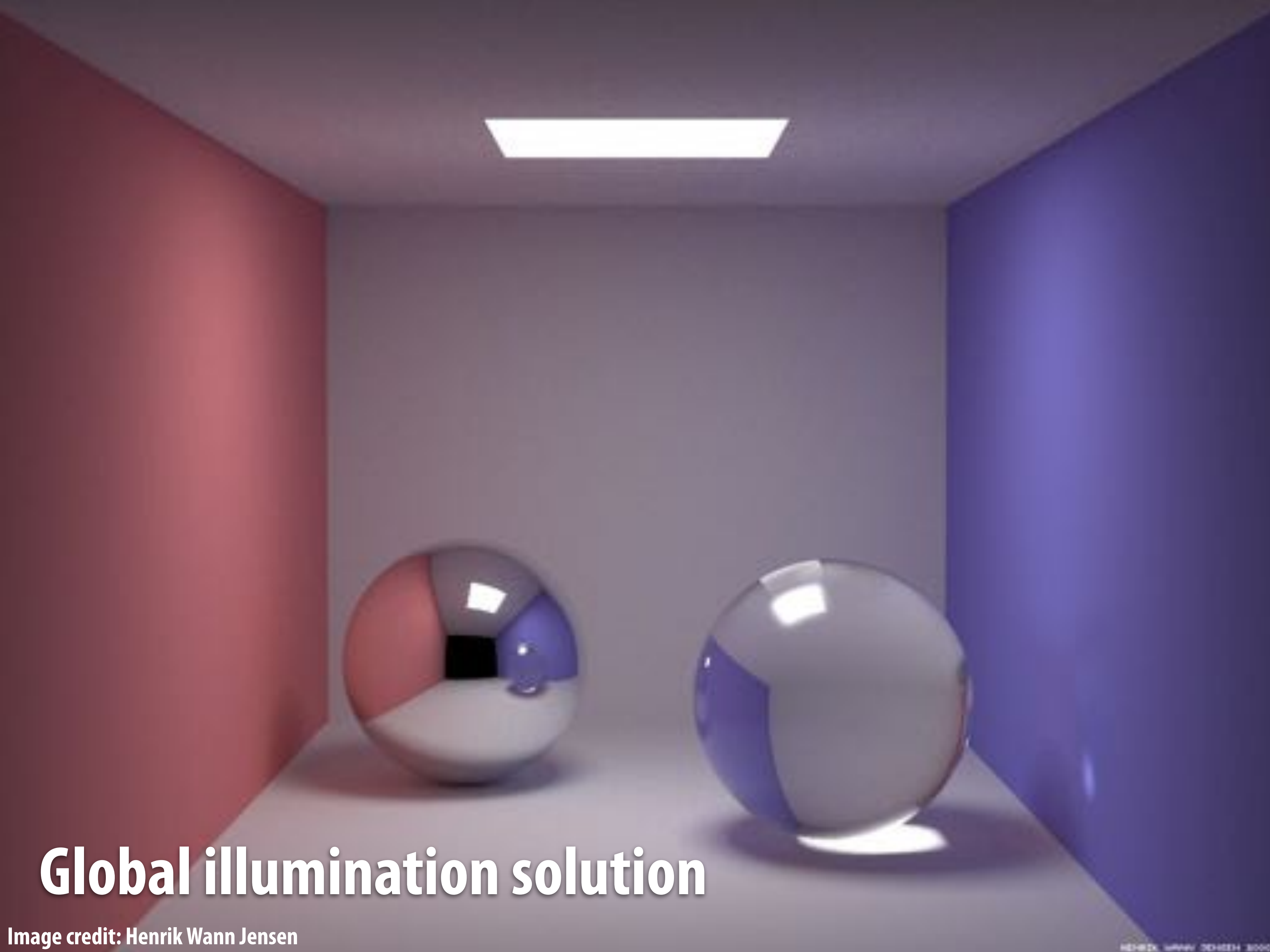

Global illumination solution

Image credit: Henrik Wann Jensen

What information are we missing?

- At the beginning, adopted “geometric optics” model of light
- Miss out on small-scale effects (e.g., diffraction/iridescence)
- Also large-scale effects (e.g., bending of light due to gravity)

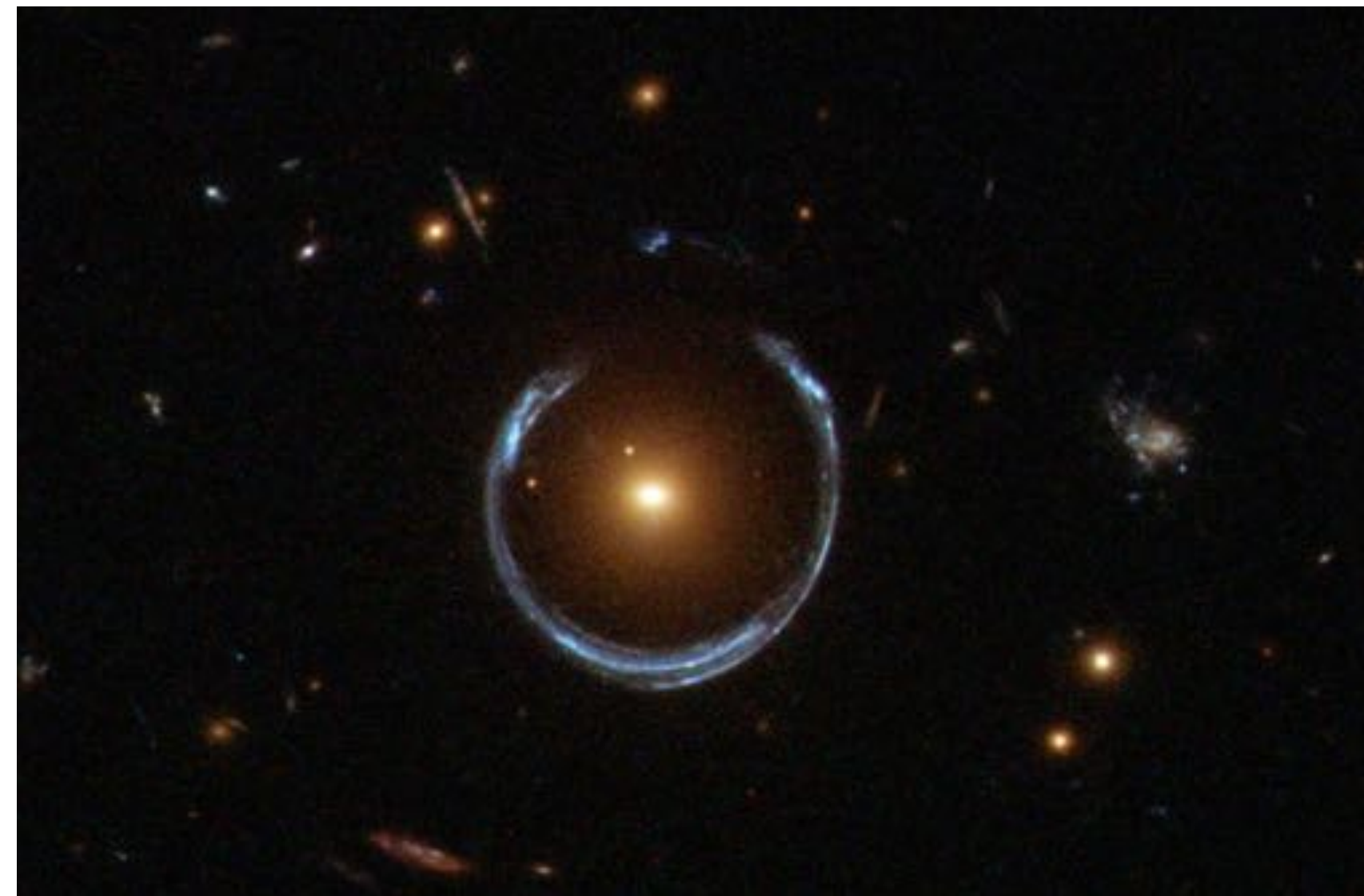

Next Time: Monte Carlo integration



$$\int_{\Omega} f(p) dp \approx \text{vol}(\Omega) \frac{1}{N} \sum_{i=1}^N f(X_i)$$