

Radiometry

Computer Graphics
CMU 15-462/15-662

Last time we discussed color

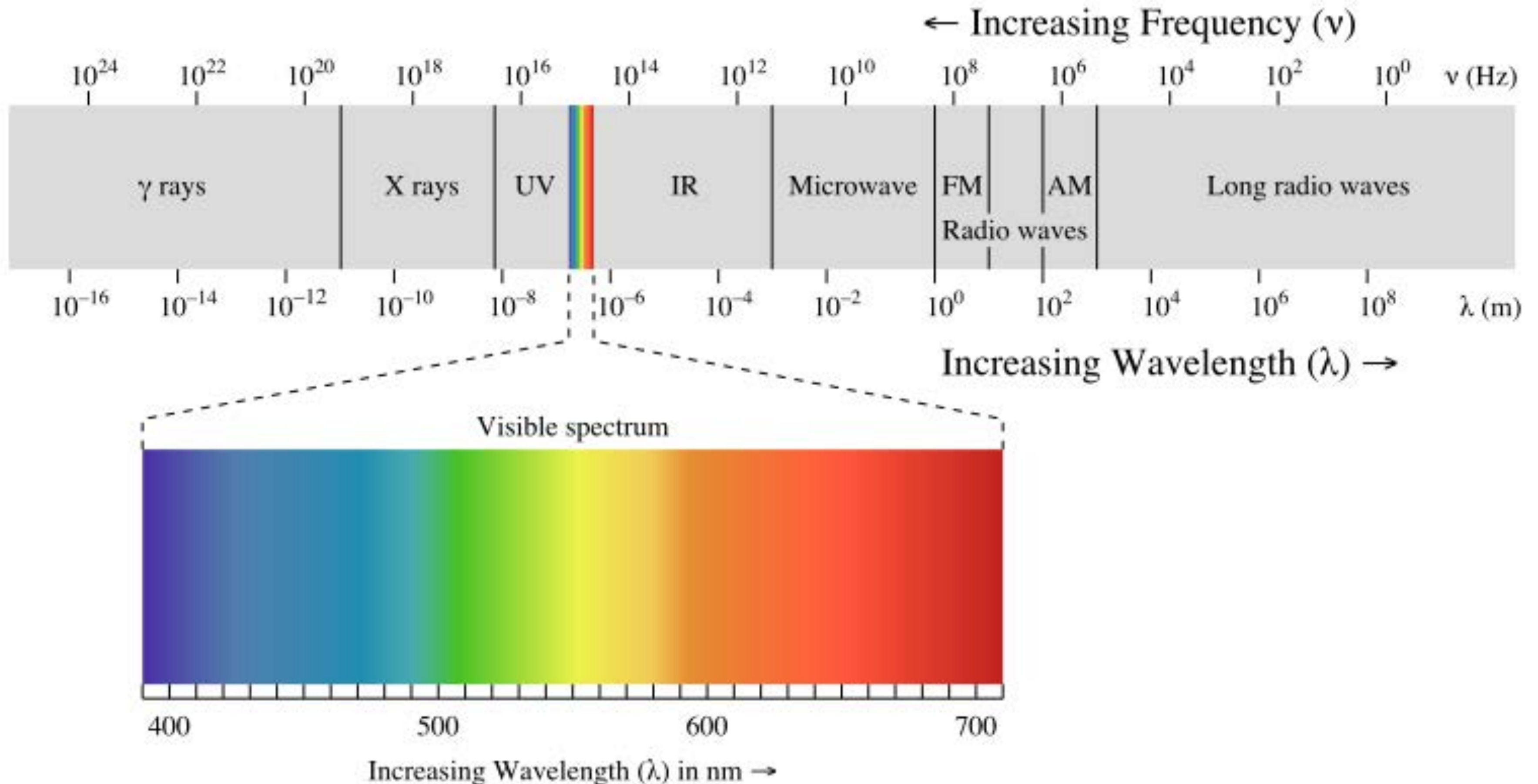

Image credit: Licensed under CC BY-SA 3.0 via Commons

https://commons.wikimedia.org/wiki/File:EM_spectrum.svg#/media/File:EM_spectrum.svg

Rendering is more than just color!

- Also need to know *how much* light hits each pixel:

color

intensity

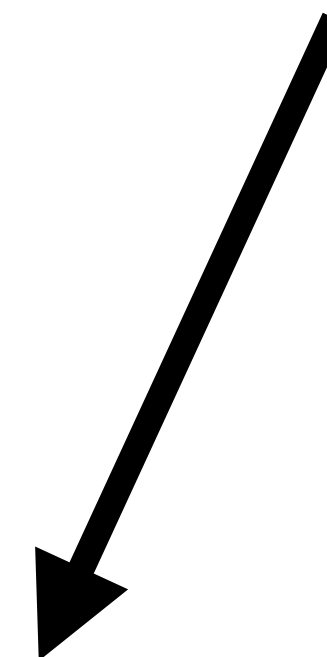
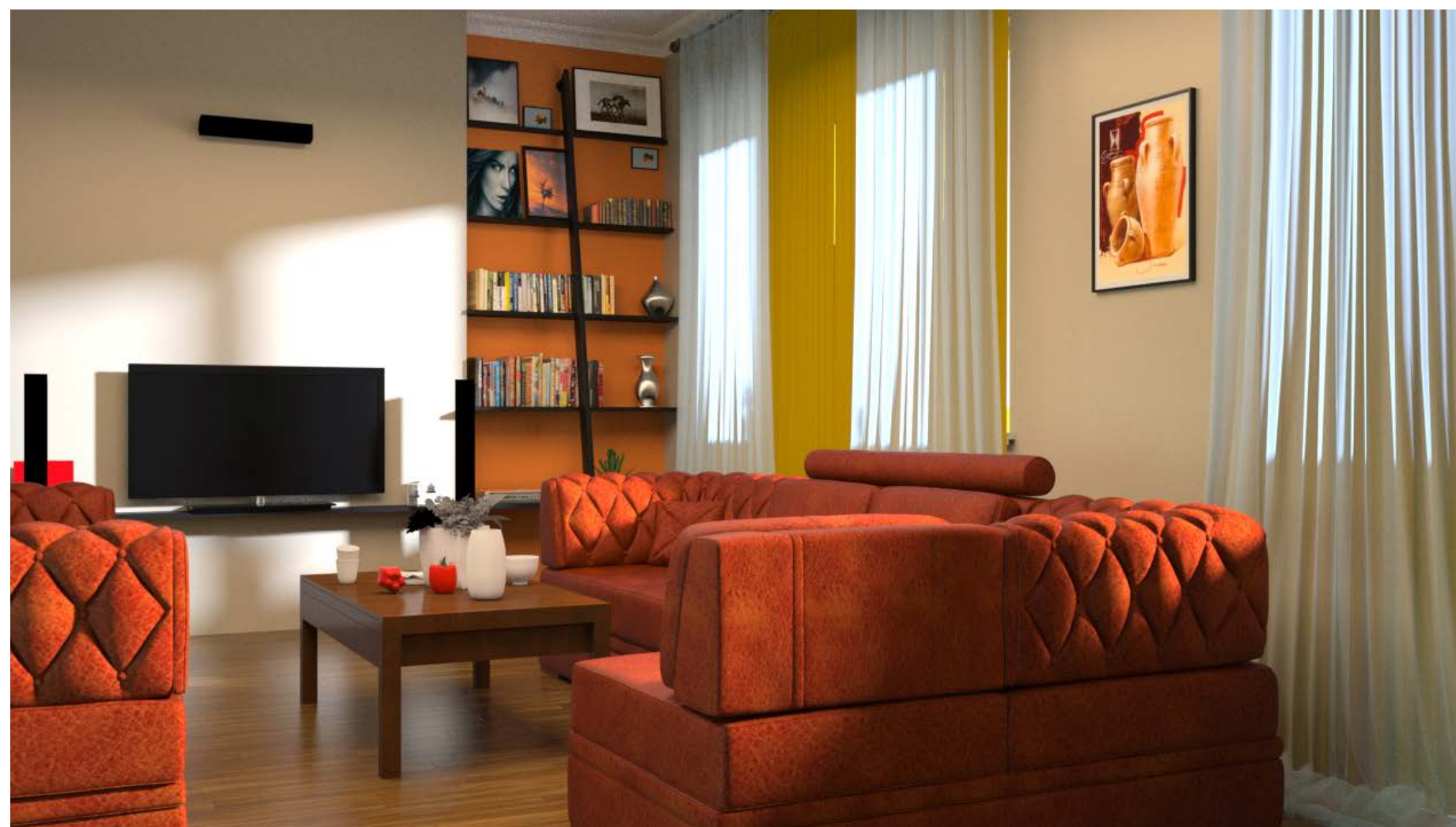
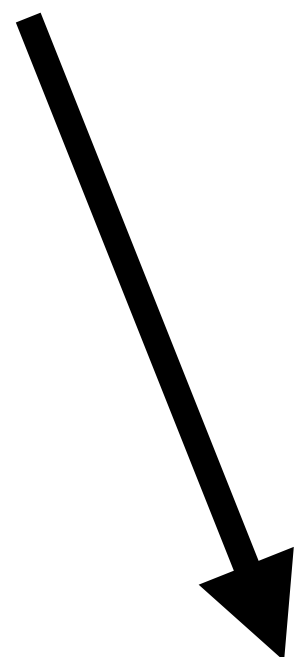

image

**How do we *quantify*
measurements of light?**

Radiometry

- **System of units and measures for measuring EM radiation (light)**
- **Geometric optics model of light**
 - **Photons travel in straight lines**
 - **Represented by rays**
 - **Wavelength \ll size of objects**
 - **No diffraction, interference, ...**
 - **LOTS of terminology!**
 - **Focus first on concepts**
 - **Terminology comes second**



Names don't constitute knowledge!



(Richard Feynman)

What do we want to measure (and why?)



- **Many physical processes convert energy into photons**
 - E.g., incandescent lightbulb turns heat into light (blackbody radiation)
 - Nuclear fusion in stars (sun!) generates photons
 - Etc.
- **Each photon carries a small amount of energy**
- **Want some way of recording “how much energy”**
- **Energy of photons hitting an object ~ “brightness”**
 - Film, eyes, CCD sensor, sunburn, solar panels, ...
 - Need this information to make accurate (and beautiful!) images
- **Simplifying assumption: “steady state” process**
 - How long does it take for lighting to reach steady state?

What does light propagation look like?

Can't see it with the naked eye!

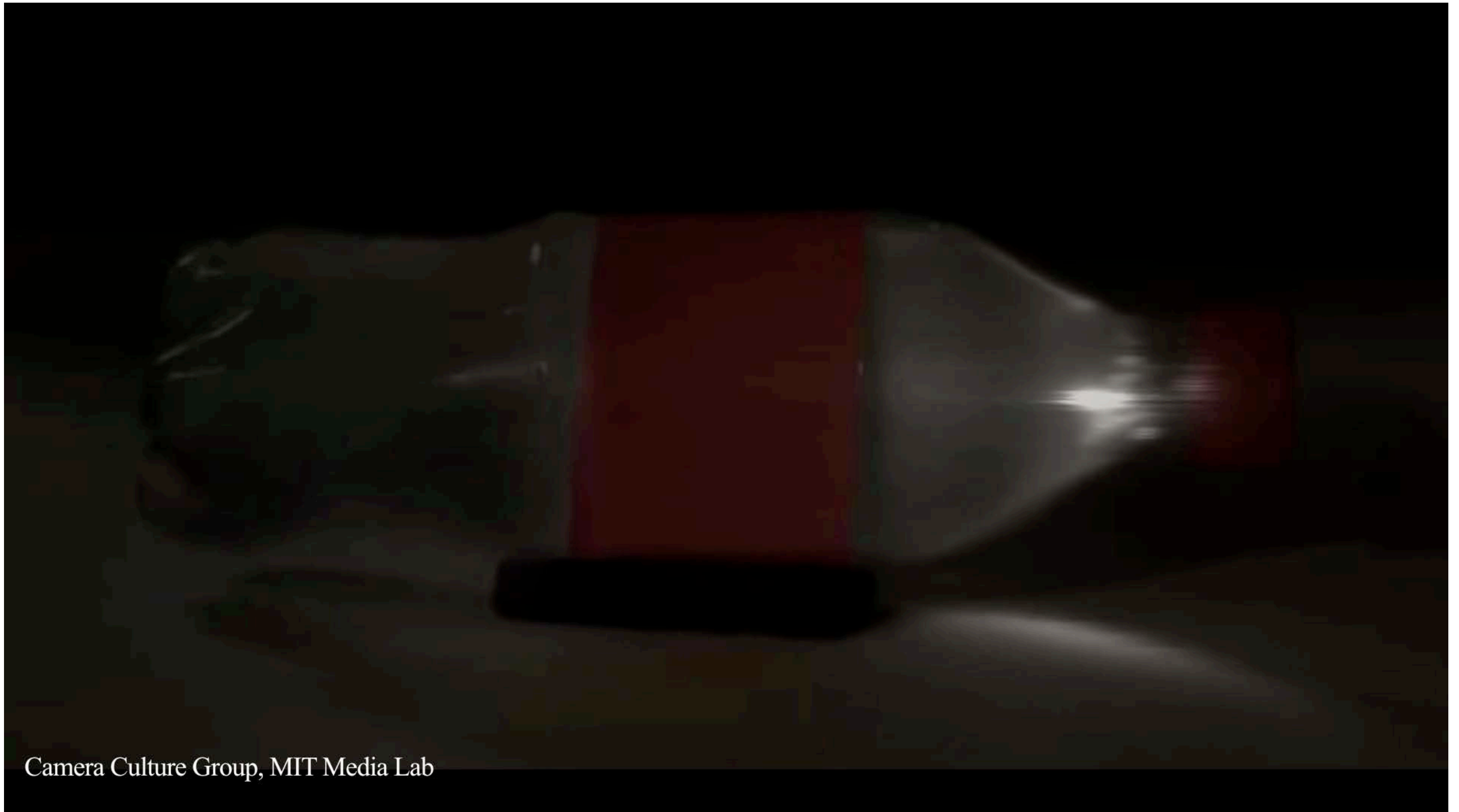

Camera Culture Group, MIT Media Lab

Instead, repeat same experiment many times, take “snapshot” at slightly different offsets each time.

Imagine every photon is a little rubber ball hitting the scene:



How can we record this process? What *information* should we store?

Radiant energy is “total # of hits”

- One idea: just store the *total* number of “hits” that occur anywhere in the scene, over the complete duration of the scene
- This quantity captures the total *energy* of all the photons hitting the scene*

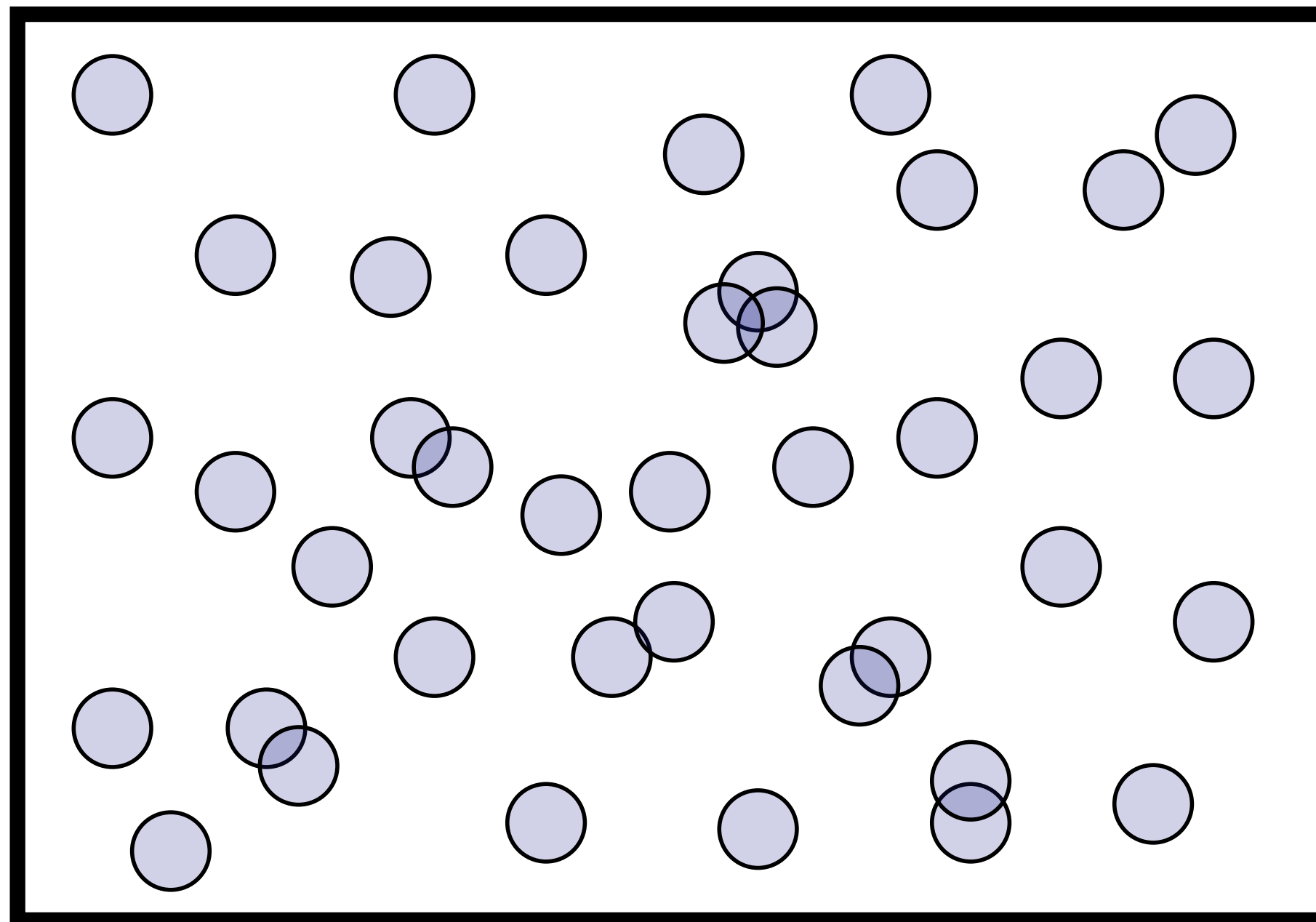

“Radiant energy”: 40

*Eventually we will care about constants & units. But these will not help our *conceptual* understanding...

Radiant flux is “hits per second”

- For illumination phenomena at the level of human perception, usually safe to assume equilibrium is reached *immediately*.
- So, rather than record total energy over some (arbitrary) duration, may make more sense to record total *hits per second*

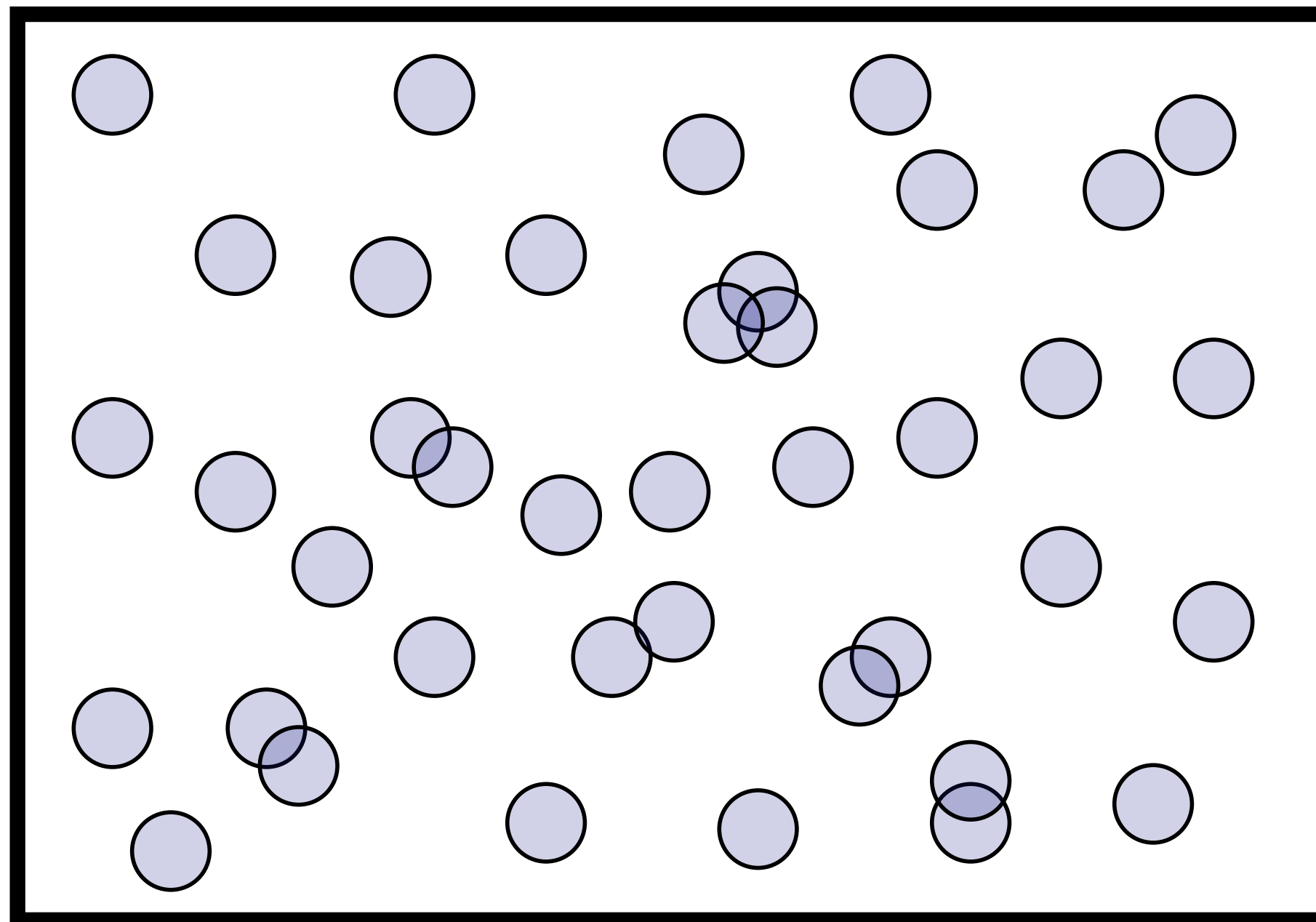

(Our video takes .05s to display each “hit”!)

Estimate of “radiant flux”: $40 \text{ hits}/2\text{s} = 20 \text{ hits/s}$

Irradiance is “#hits per second, per unit area”

- Typically we want to get more specific than just the total
- To make images, also need to know *where* hits occurred
- So, compute hits per second in some “*really small*” area, divided by area:

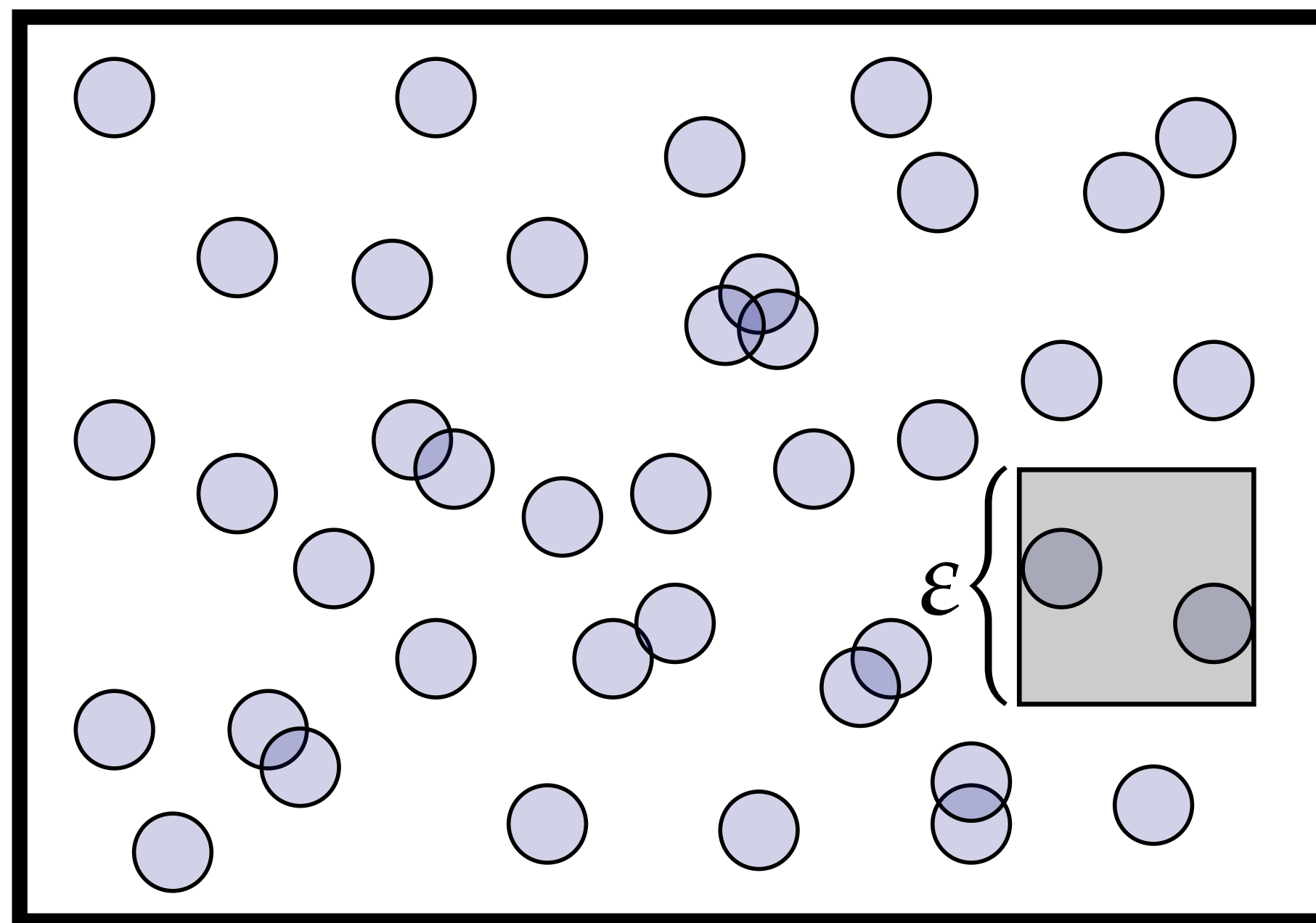

Estimate of “radiant energy density”: $2/\epsilon^2$

Image generation as irradiance estimation

- From this point of view, our goal in image generation is to estimate the irradiance at each point of an image (or really: the total radiant flux per pixel...):

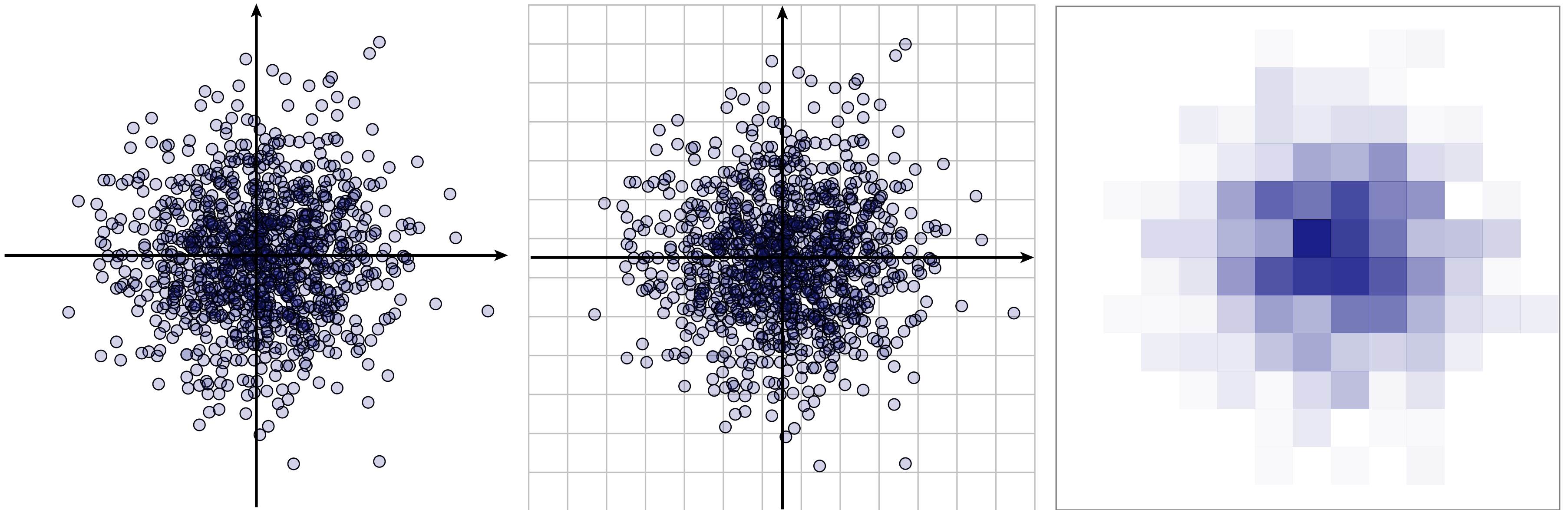

Recap so far...

Radiant Energy
(total number of hits)

Radiant Energy Density
(hits per unit area)

Radiant Flux
(total hits per second)

Radiant Flux Density
a.k.a. *Irradiance*
(hits per second per unit area)

Ok, but how about some units...

Measuring illumination: radiant energy

- How can we be more precise about the amount of energy?
- Said we were just going to count “the number of hits,” but do all hits contribute same amount of *energy*?
- Energy of a single photon:

$$Q = \frac{hc}{\lambda}$$

Planck's constant h speed of light c wavelength (color!) λ

$$h \approx 6.626 \times 10^{-34} \text{ J}\cdot\text{s} \quad (\text{Joules times seconds})$$

$$c \approx 3.00 \times 10^8 \text{ m/s} \quad (\text{meters per second})$$

$$\lambda \approx 390\text{--}700 \times 10^{-3} \text{ m (visible)}$$

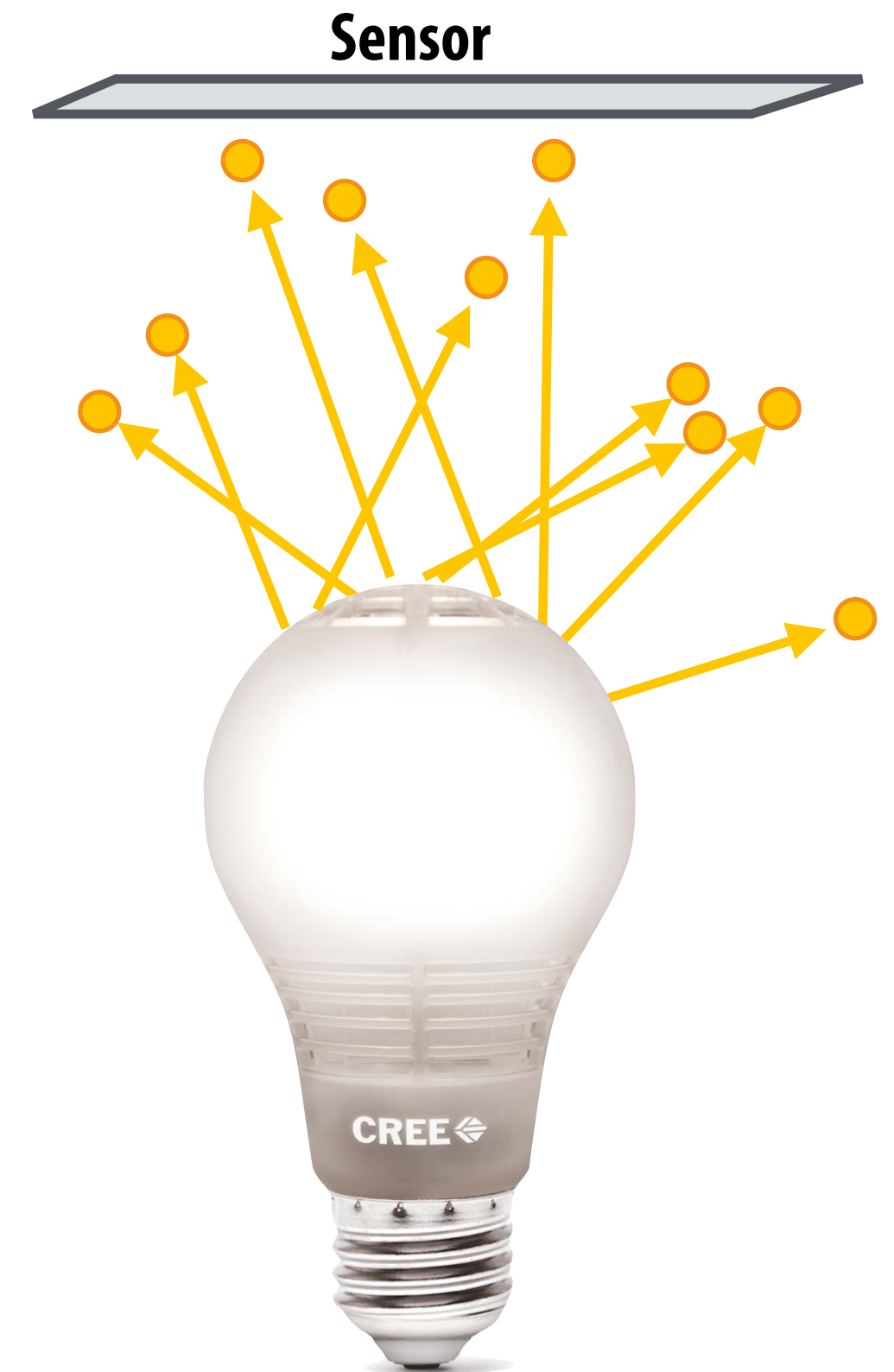

Q: What are units for a photon?

$$\frac{(\text{J} \times \text{s})(\text{m/s})}{\text{m}} = \text{J}$$

Aside: Units are a powerful *debugging* tool!

Measuring illumination: radiant flux (power)

- **Flux: energy *per unit time* (Watts) received by the sensor (or emitted by the light)**

$$\Phi = \lim_{\Delta t \rightarrow 0} \frac{\Delta Q}{\Delta t} = \frac{dQ}{dt} \left[\frac{\text{J}}{\text{s}} \right] \leftarrow \text{"Watts"}$$

- **Can also go the other direction: time integral of flux is total radiant energy**

$$Q = \int_{t_0}^{t_1} \Phi(t) dt$$

(Units?)

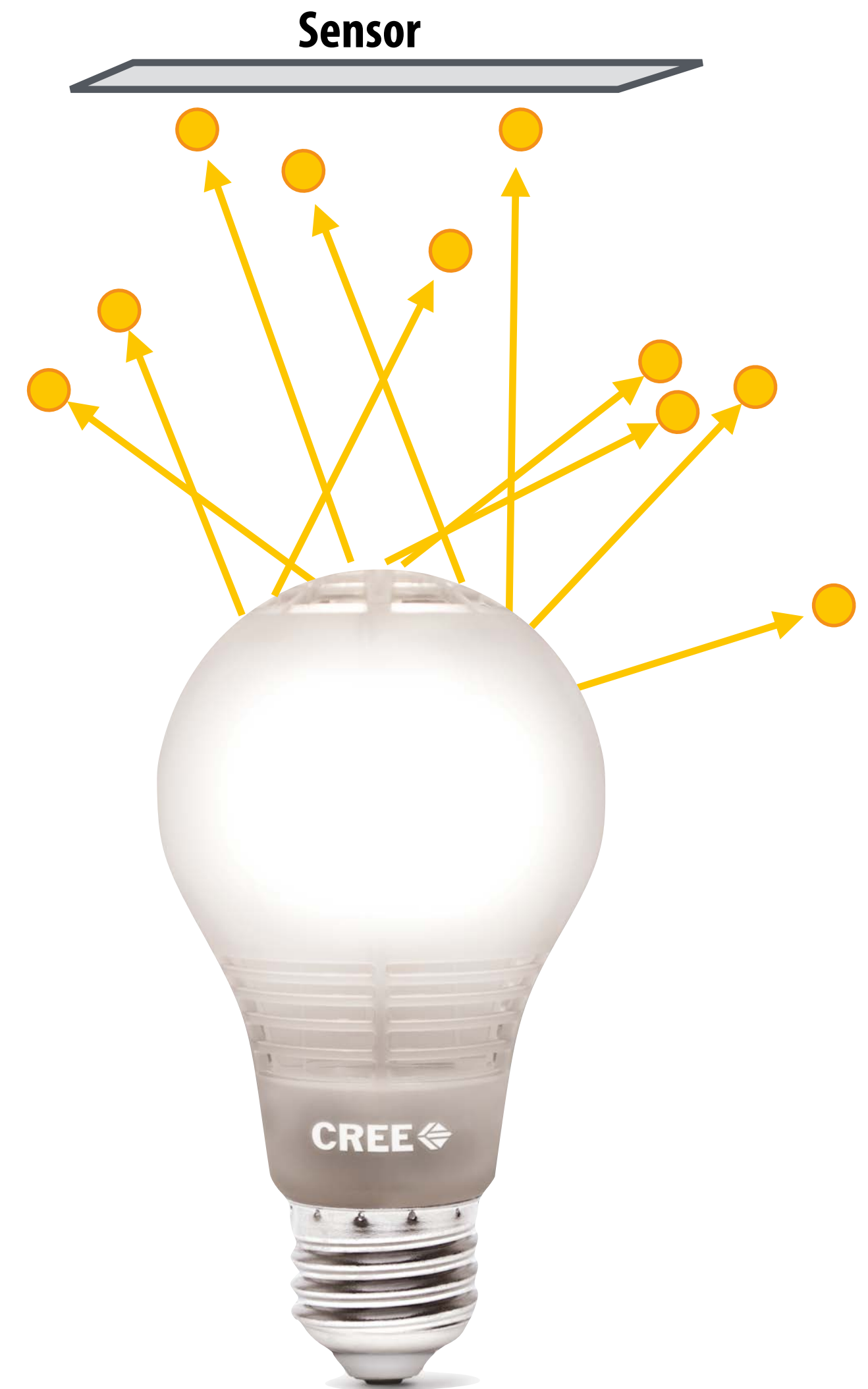

Measuring illumination: irradiance

- Radiant flux: time density of energy
- Irradiance: area density of radiant flux

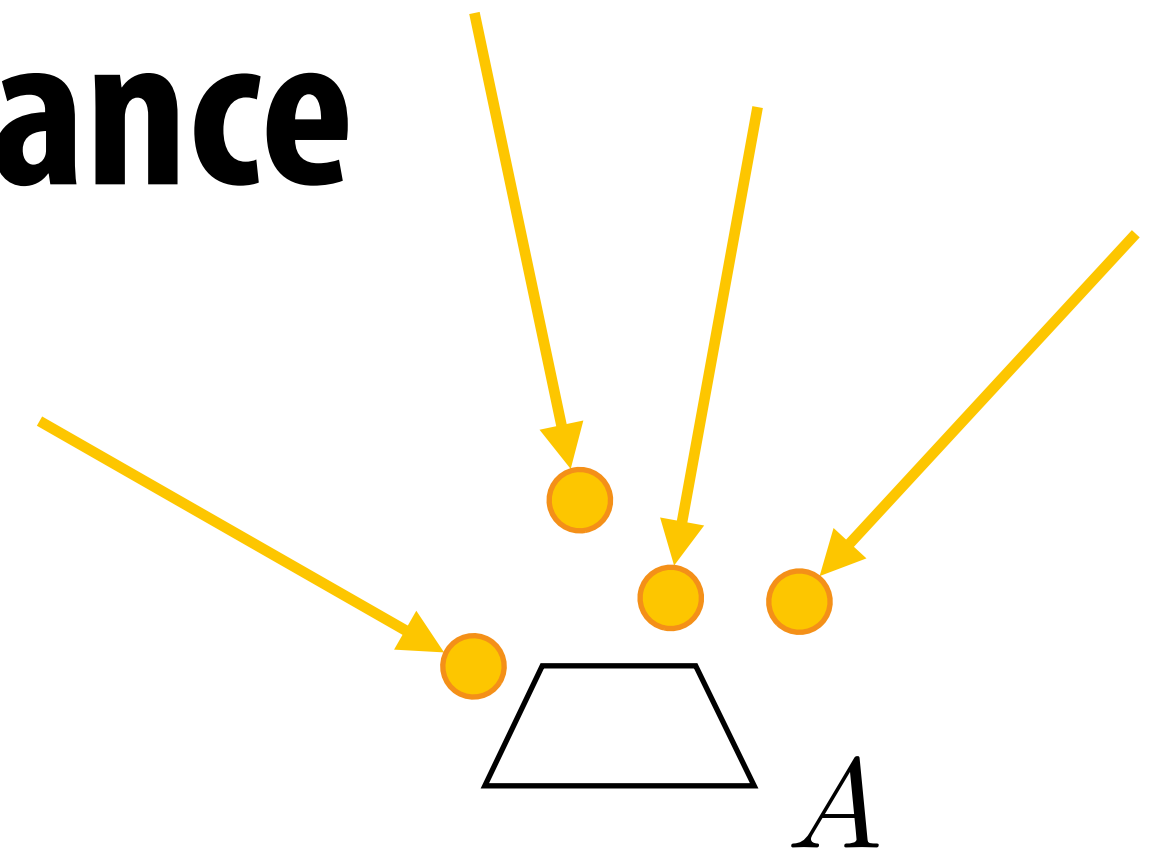

Given a sensor of with area A , we can consider the average flux over the entire sensor area:

$$\frac{\Phi}{A}$$

Irradiance (E) is given by taking the limit of area at a single point on the sensor:

$$E(p) = \lim_{\Delta \rightarrow 0} \frac{\Delta \Phi(p)}{\Delta A} = \frac{d\Phi(p)}{dA} \left[\frac{\text{W}}{\text{m}^2} \right]$$

Recap, with units

Radiant Energy

(total number of hits)

Joules (J)

Radiant Energy Density

(hits per unit area)

Joules per square meter (J/m²)

Radiant Flux

(total hits per second)

Joules per second (J/s) = Watts (W)

Radiant Flux Density

a.k.a. *Irradiance*

(hits per second per unit area)

Watts per square meter (W/m²)

What about *color*?

**How might we quantify, say, the
“amount of **green**?”**

Spectral power distribution

- Describes irradiance *per unit wavelength* (units?)

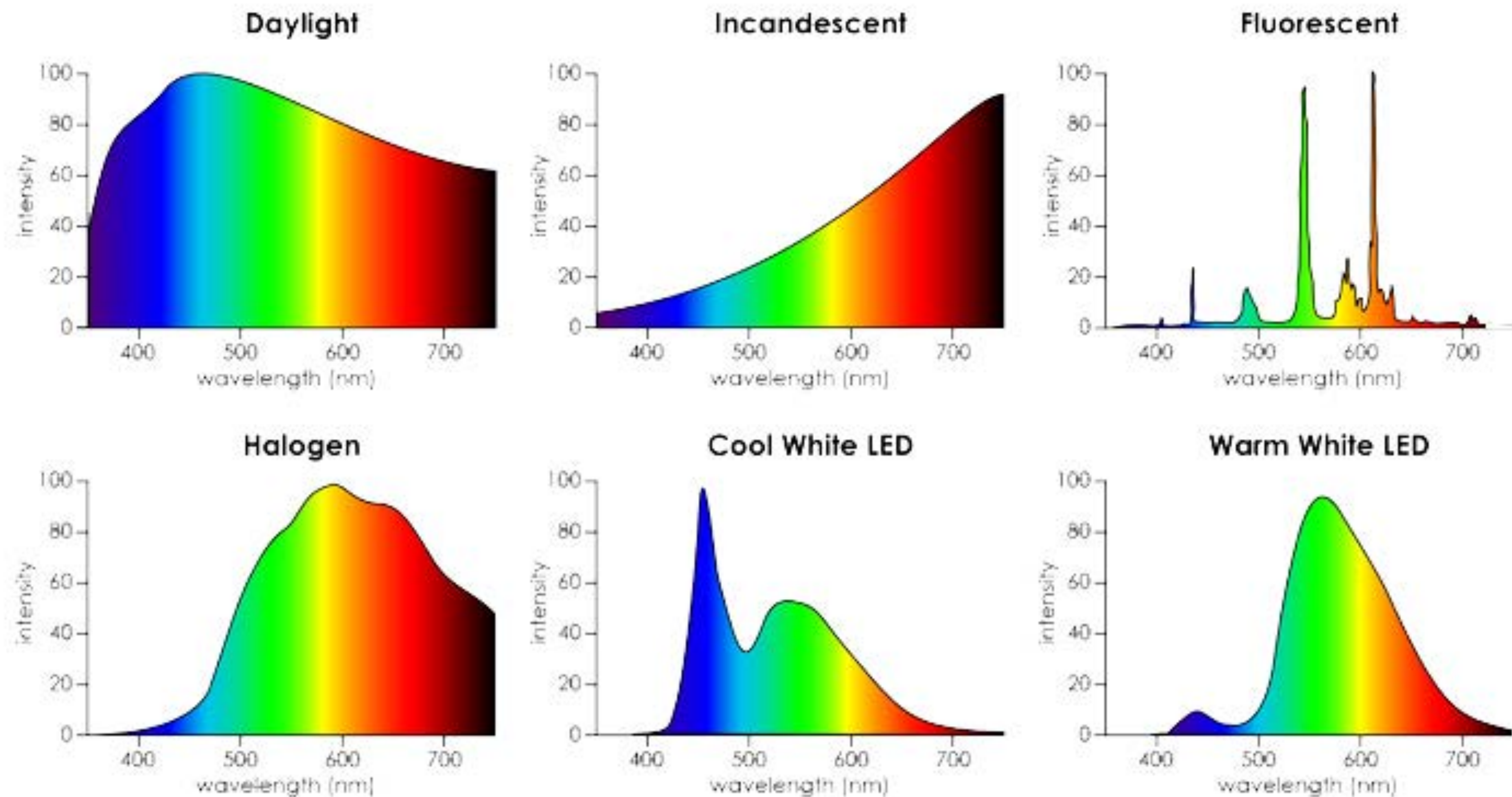

Energy per unit time per unit area per unit wavelength...

Figure credit:

**Given what we now know
about radiant energy...**



**Why do some parts of a
surface look lighter or darker?**

Why do we have seasons?

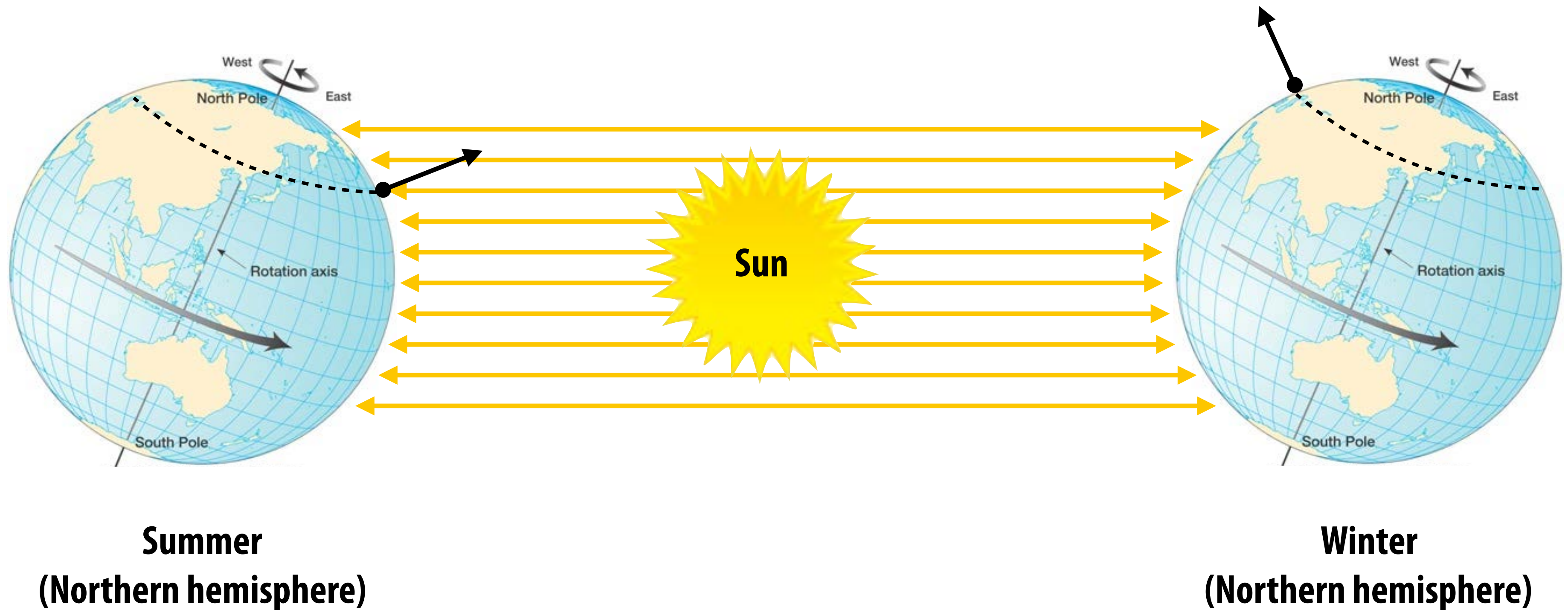

Earth's axis of rotation: $\sim 23.5^\circ$ off axis

Beam power in terms of irradiance

Consider beam with flux Φ incident on surface with area A

irradiance
(energy per time,
per area)

radiant flux
(energy per time)

$$E = \frac{\Phi}{A}$$

$$\Phi = EA$$



Projected area

Consider beam with flux Φ incident on angled surface with area A'

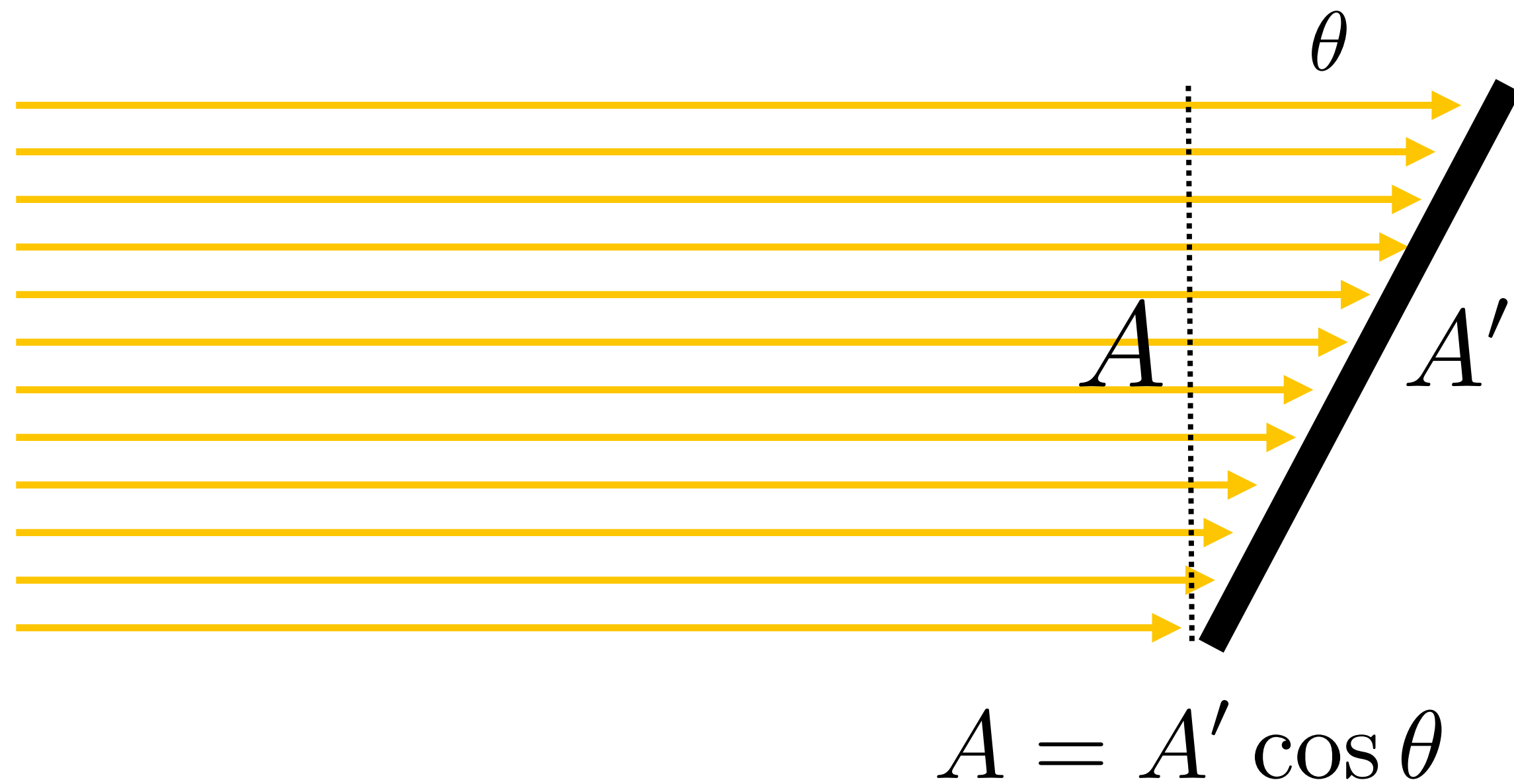

A = projected area of surface relative to direction of beam

Lambert's Law

Irradiance at surface is proportional to cosine of angle between light direction and surface normal.

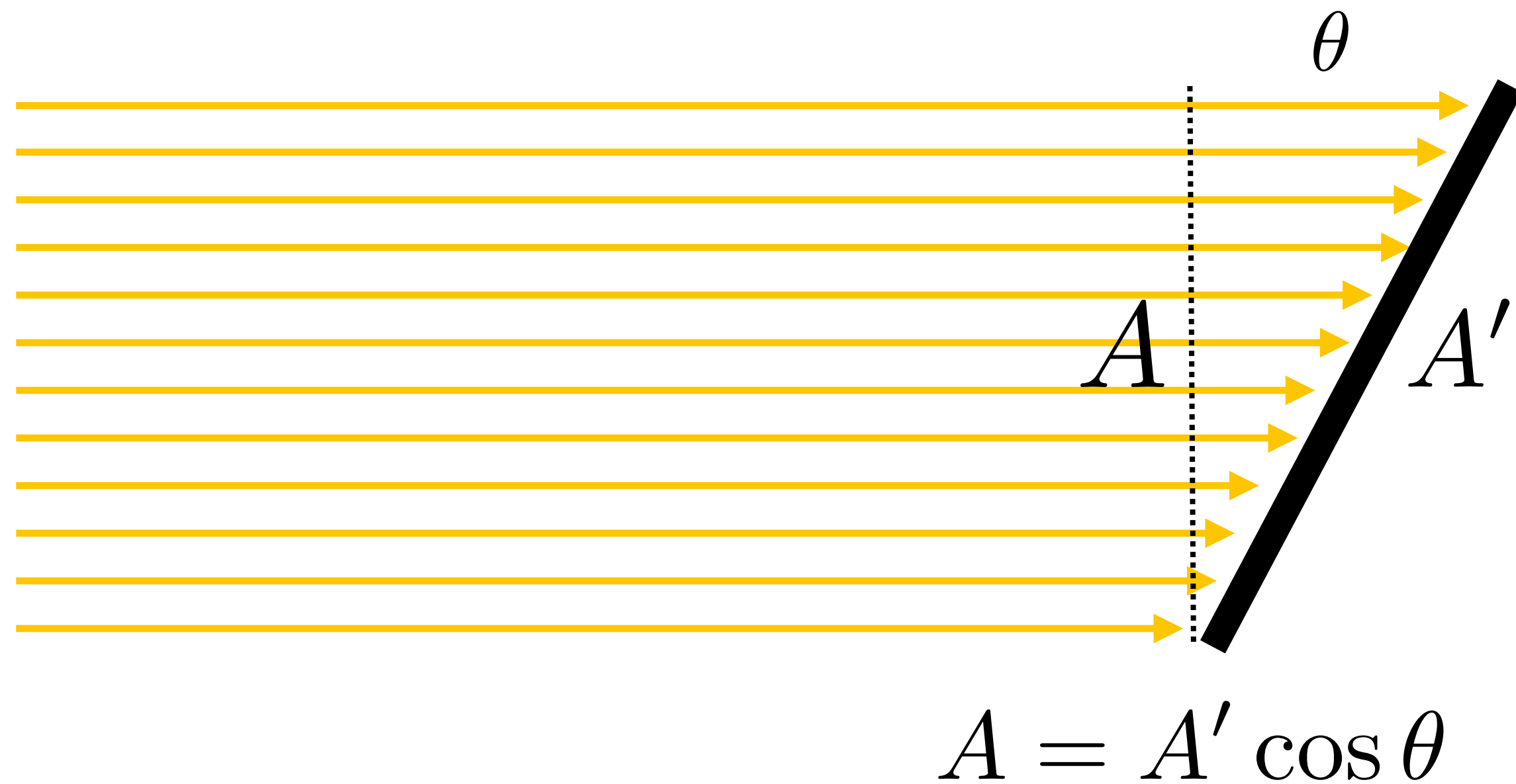

$$E = \frac{\Phi}{A'} = \frac{\Phi \cos \theta}{A}$$

“N-dot-L” lighting

- Most basic way to shade a surface: take dot product of unit surface normal (N) and unit direction to light (L)

```
double surfaceColor( Vec3 N, Vec3 L )  
{  
    return dot( N, L );  
}
```

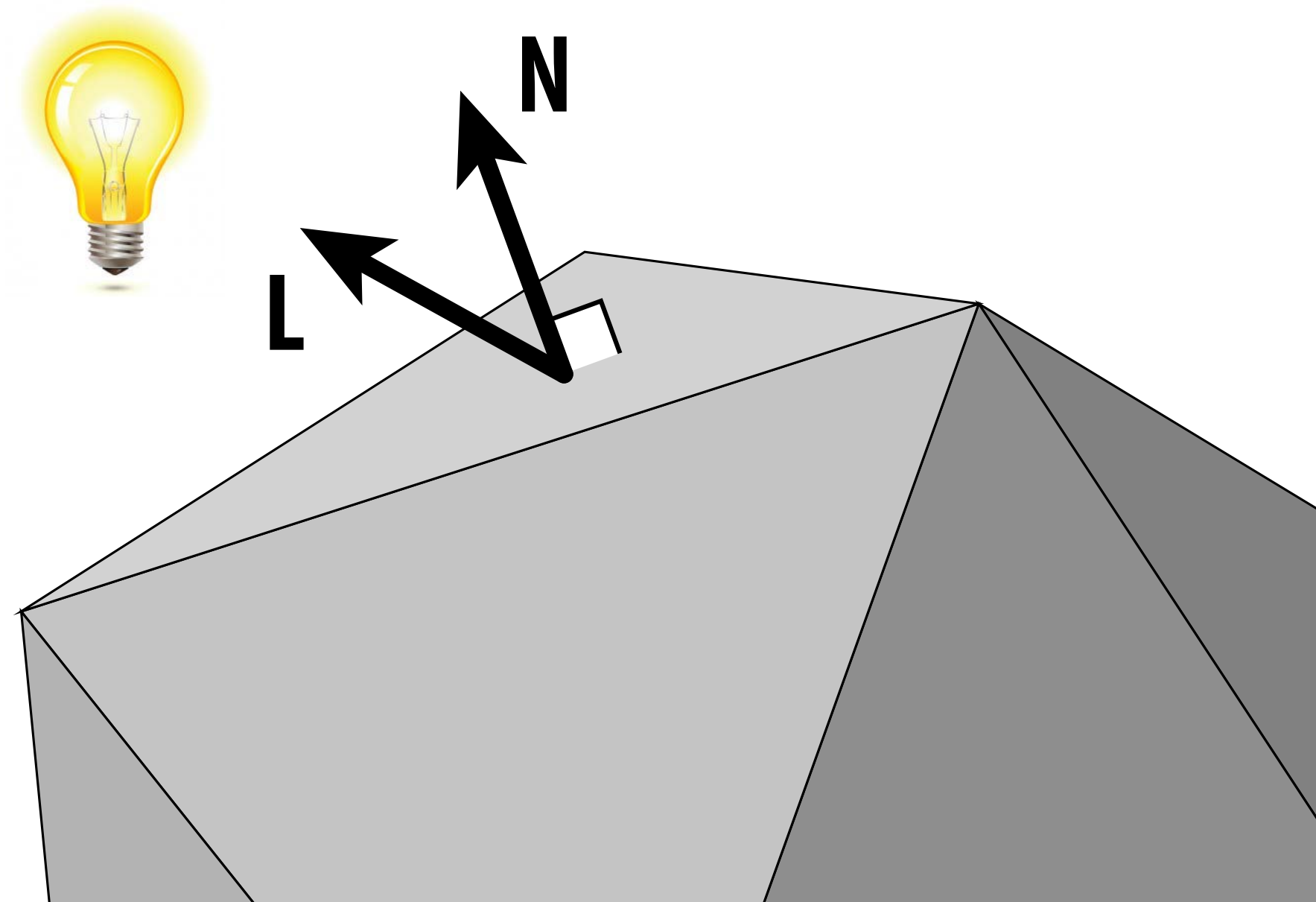

(Q: What's wrong with this code?)

“N-dot-L” lighting

- Most basic way to shade a surface: take dot product of unit surface normal (N) and unit direction to light (L)

```
double surfaceColor( Vec3 N, Vec3 L )  
{  
    return max( 0., dot( N, L ) );  
}
```

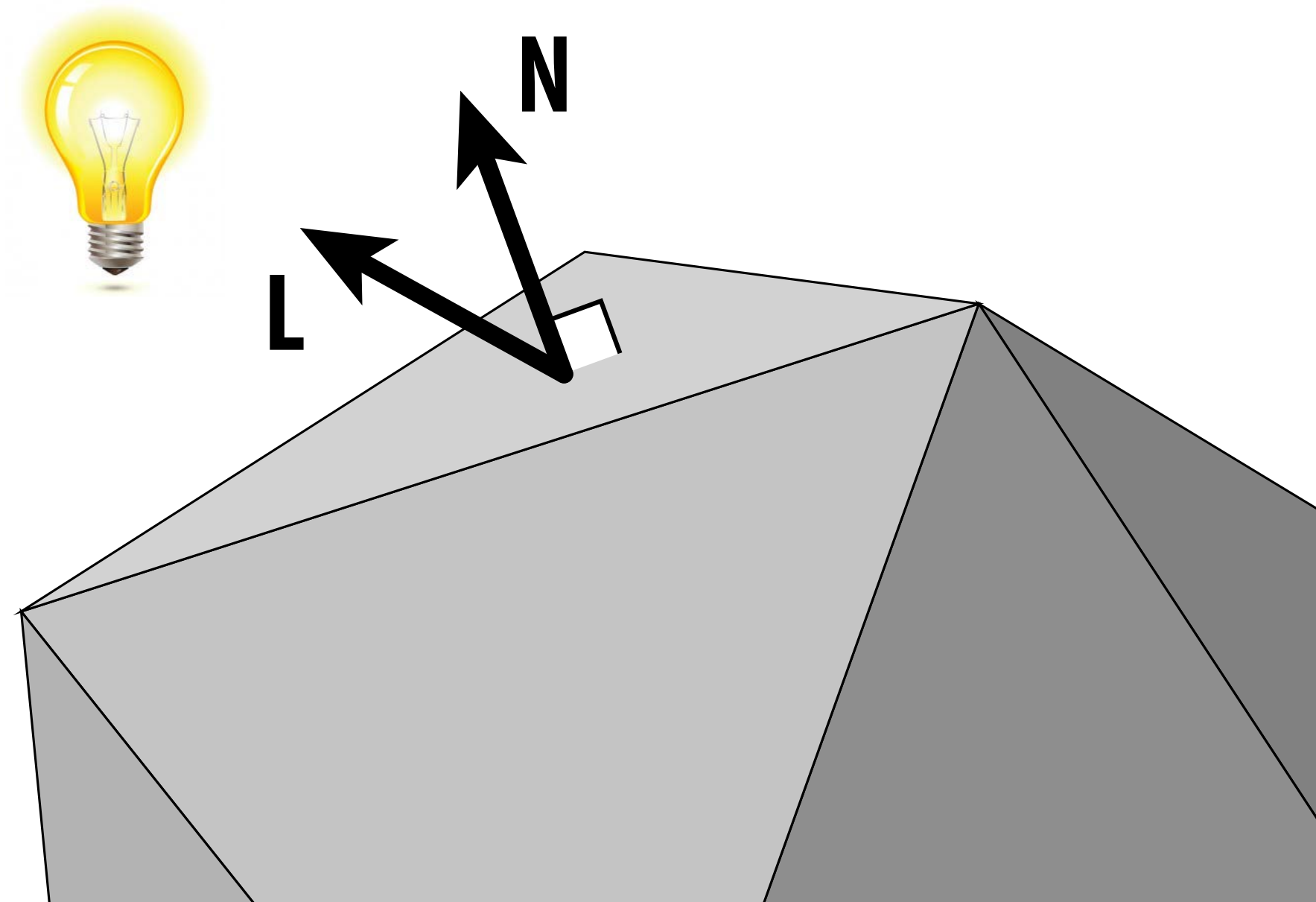

Example: “directional” lighting

- Common abstraction: infinitely bright light source “at infinity”
- All light directions (L) are therefore identical

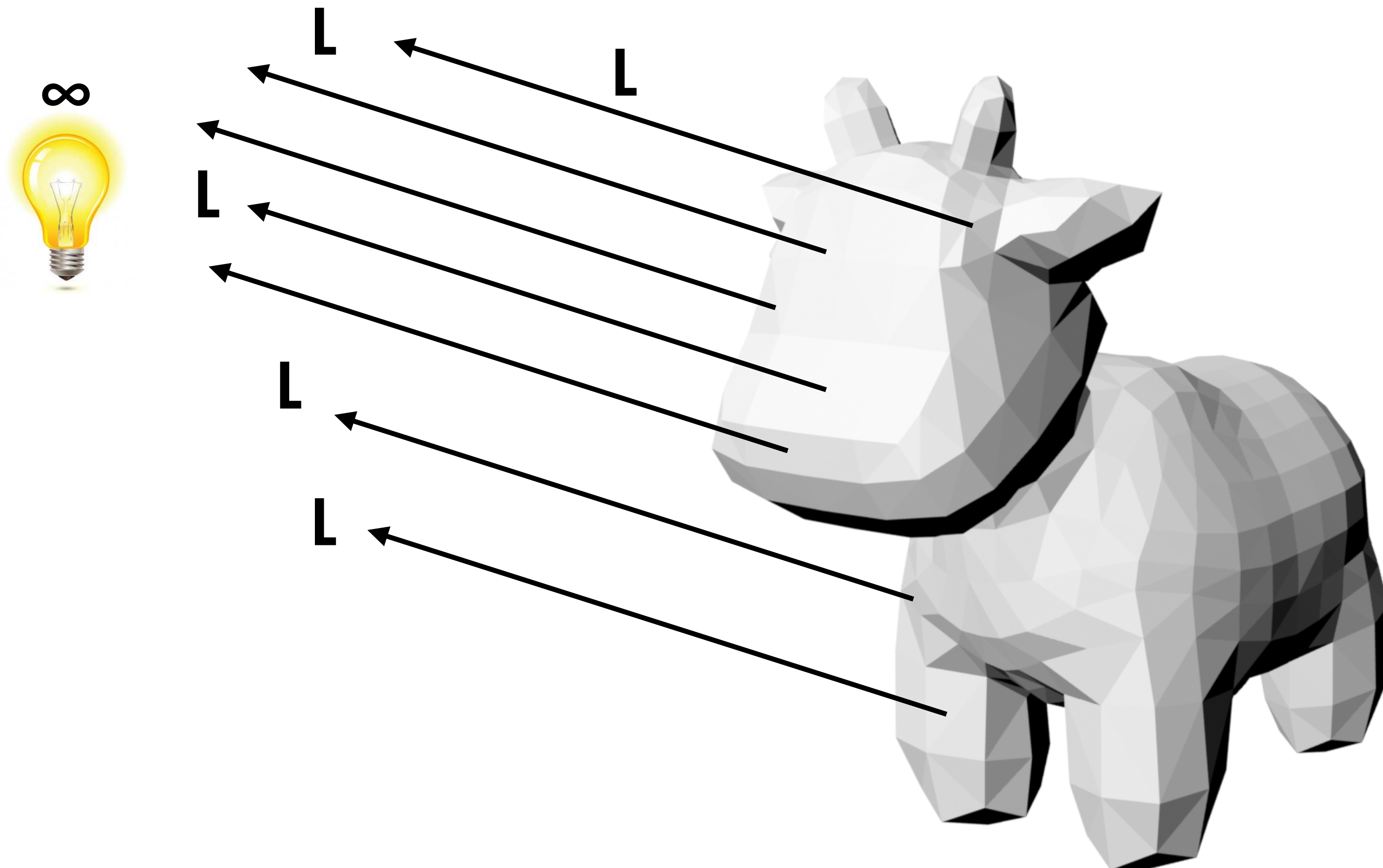

Isotropic point source

Slightly more realistic model...

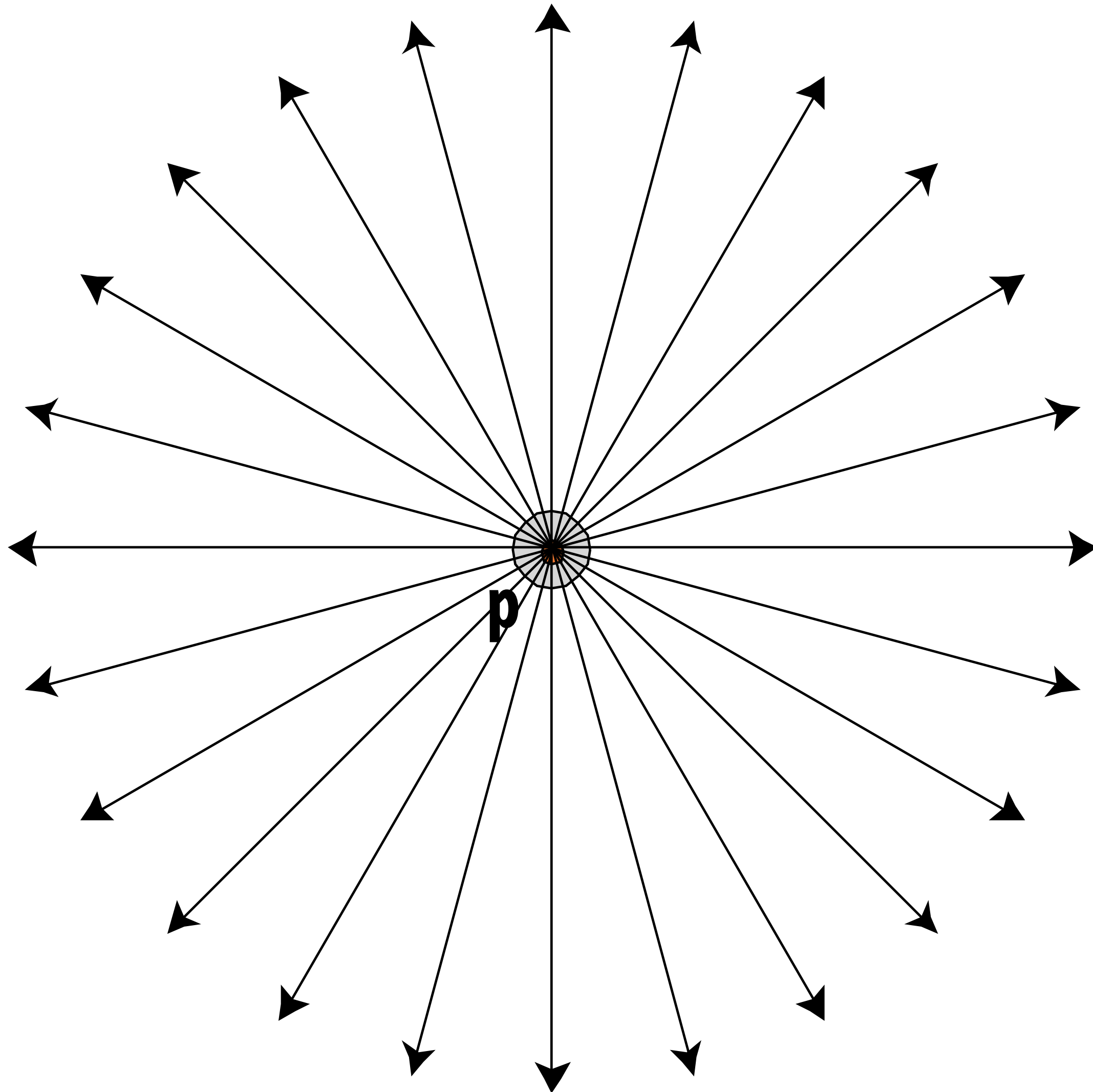

Suppose our light is such that:

total radiant flux

"intensity"

$$\Phi = \int_{S^2} I \, d\omega$$
$$= 4\pi I$$

$$I = \frac{\Phi}{4\pi}$$

Irradiance falloff with distance

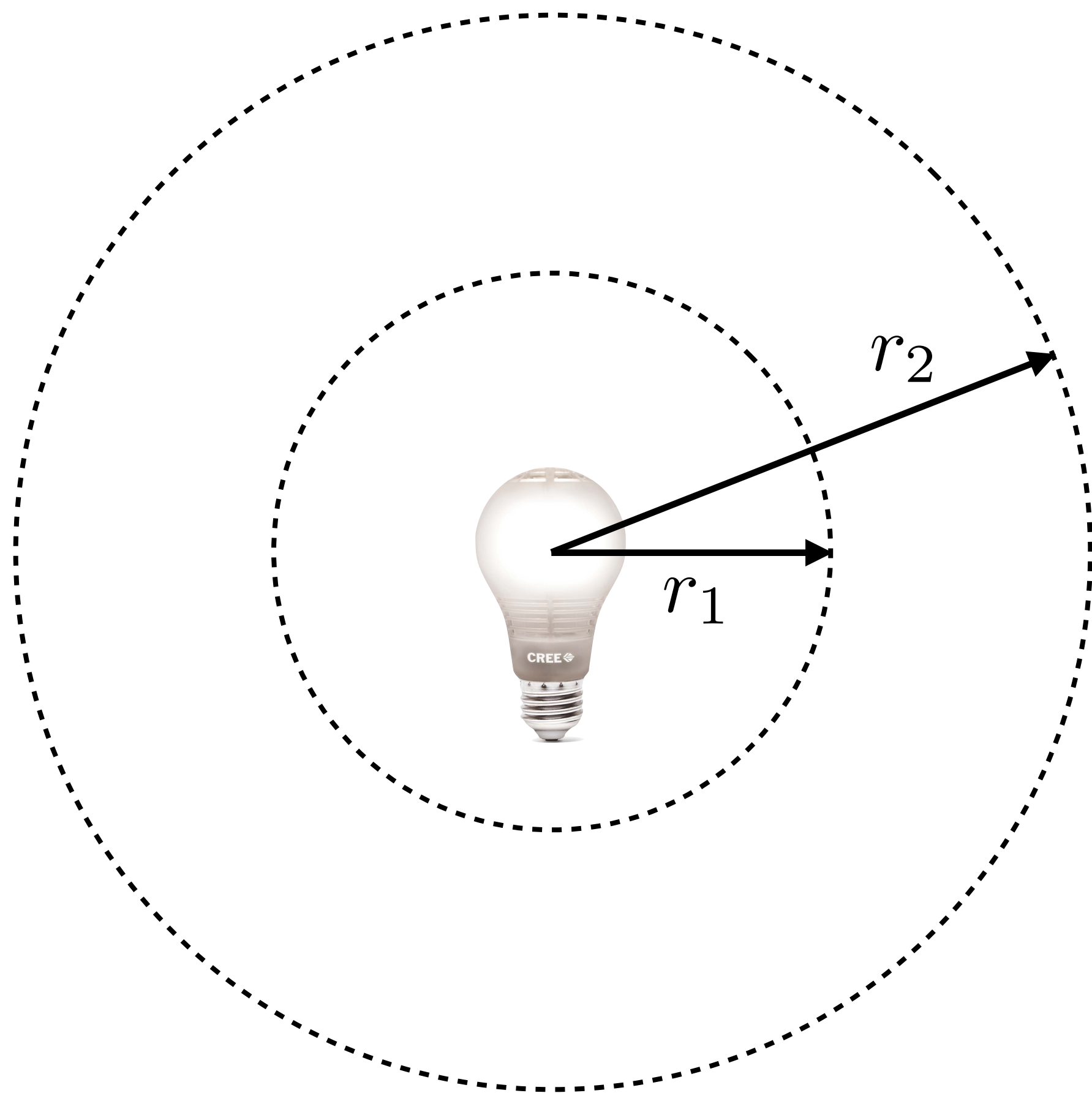

Since same amount of energy is distributed over larger and larger spheres, has to get darker quadratically with distance.

Assume light is emitting flux Φ in a uniform angular distribution

Compare irradiance at surface of two spheres:

$$E_1 = \frac{\Phi}{4\pi r_1^2} \rightarrow \Phi = 4\pi r_1^2 E_1$$

$$E_2 = \frac{\Phi}{4\pi r_2^2} \rightarrow \Phi = 4\pi r_2^2 E_2$$

$$\frac{E_2}{E_1} = \frac{r_1^2}{r_2^2} = \left(\frac{r_1}{r_2}\right)^2$$

What does quadratic falloff *look* like?

Single point light, move in 1m increments:

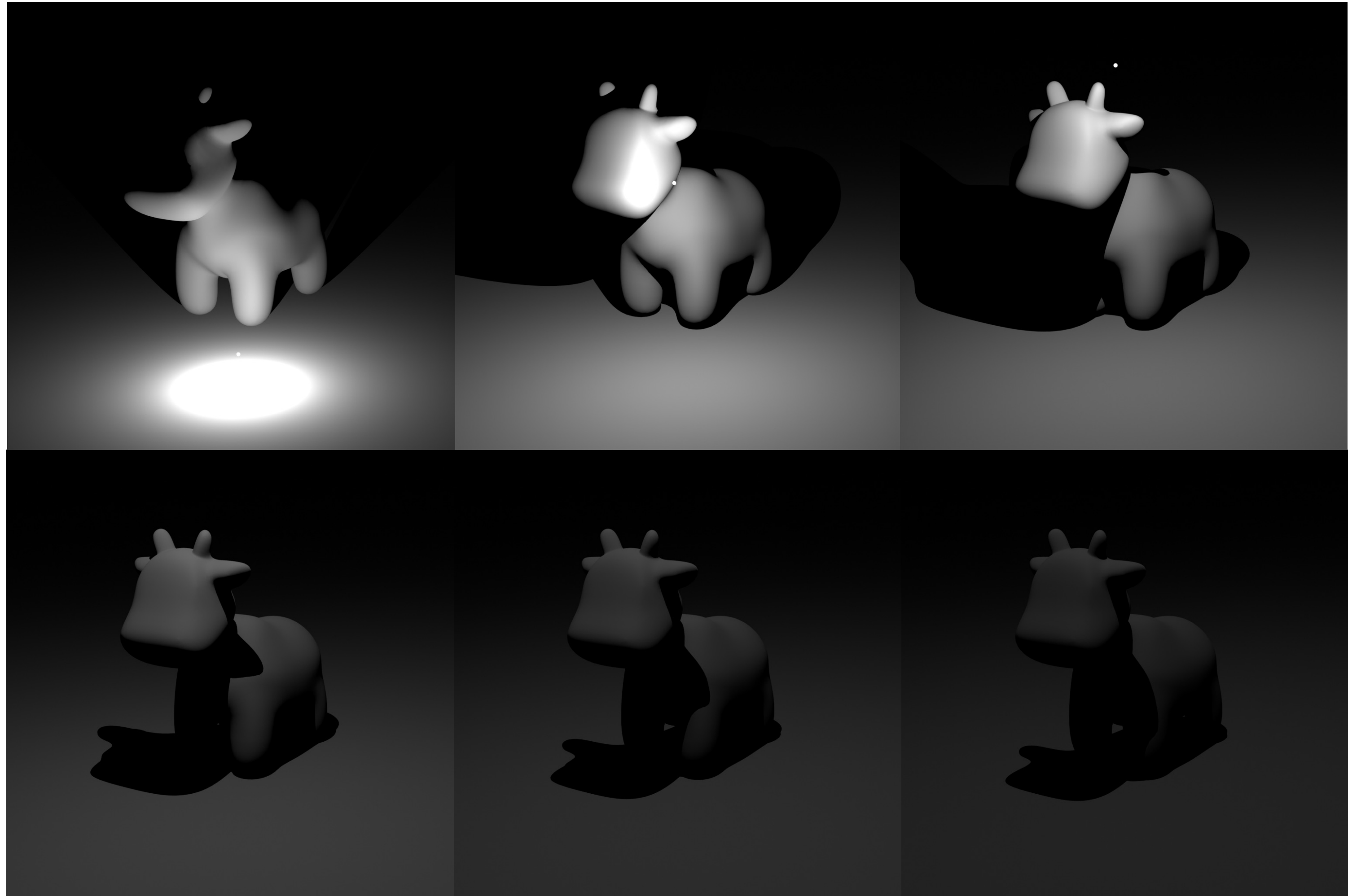

...things get dark fast!

Angles and solid angles

- **Angle: ratio of subtended arc length on circle to radius**

- $\theta = \frac{l}{r}$
- **Circle has 2π radians**

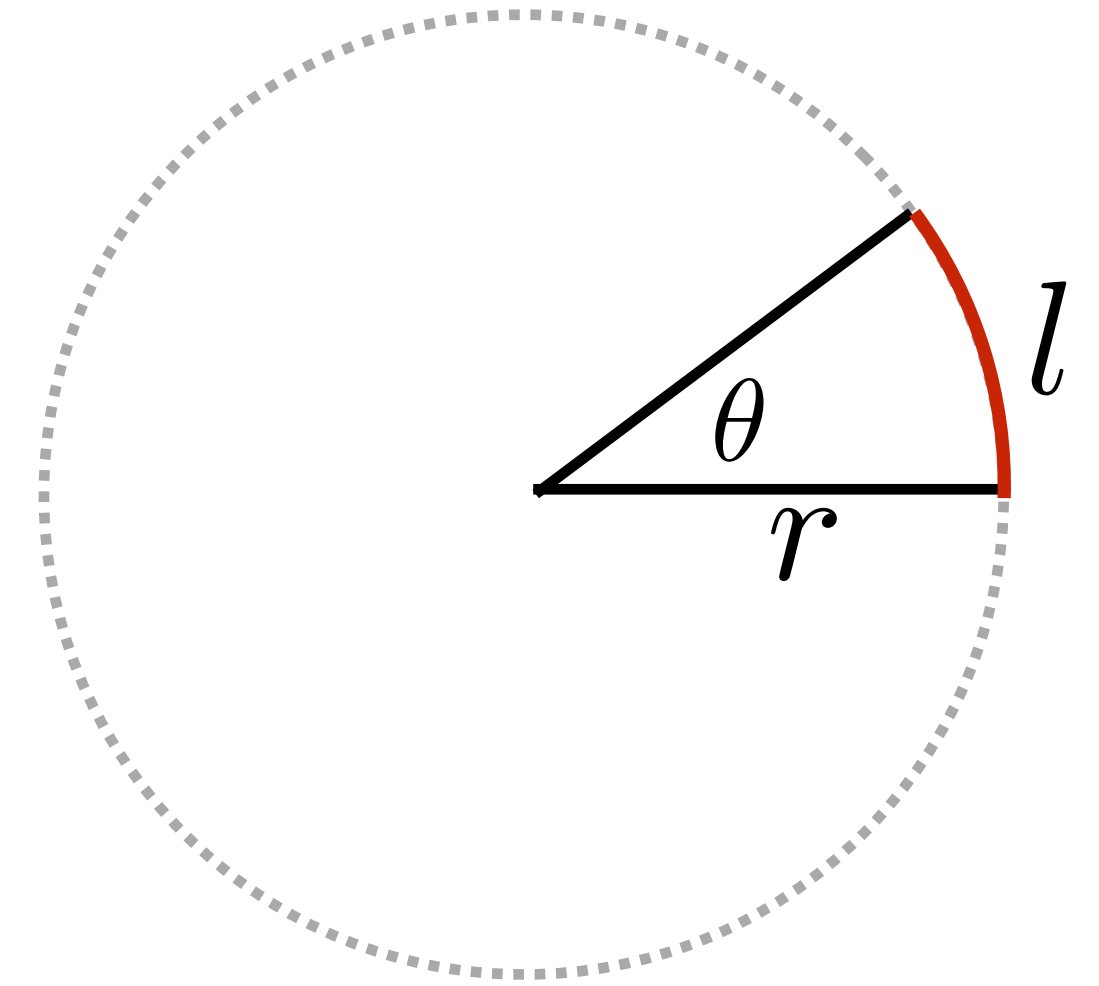

- **Solid angle: ratio of subtended area on sphere to radius squared**

- $\Omega = \frac{A}{r^2}$
- **Sphere has 4π steradians**

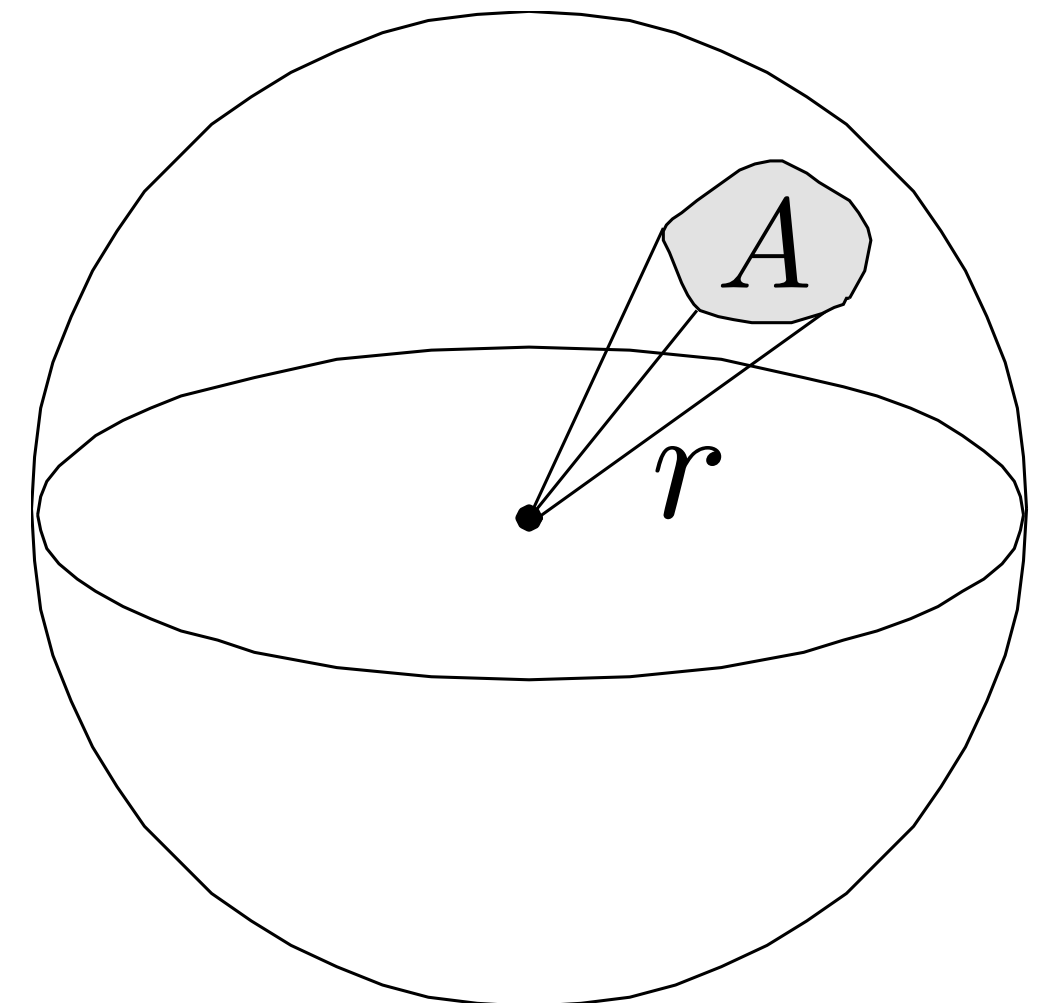

Solid angles in practice

THE SIZE OF THE PART OF EARTH'S SURFACE DIRECTLY UNDER VARIOUS SPACE OBJECTS

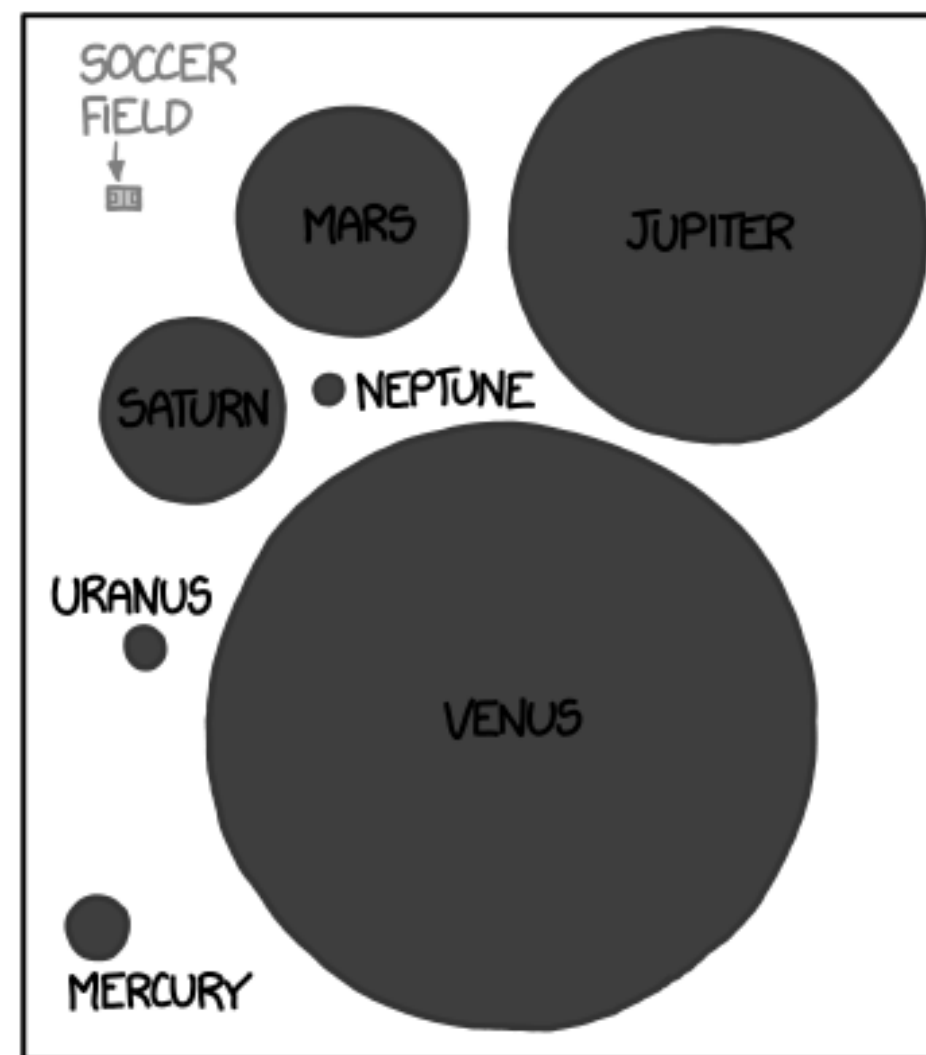
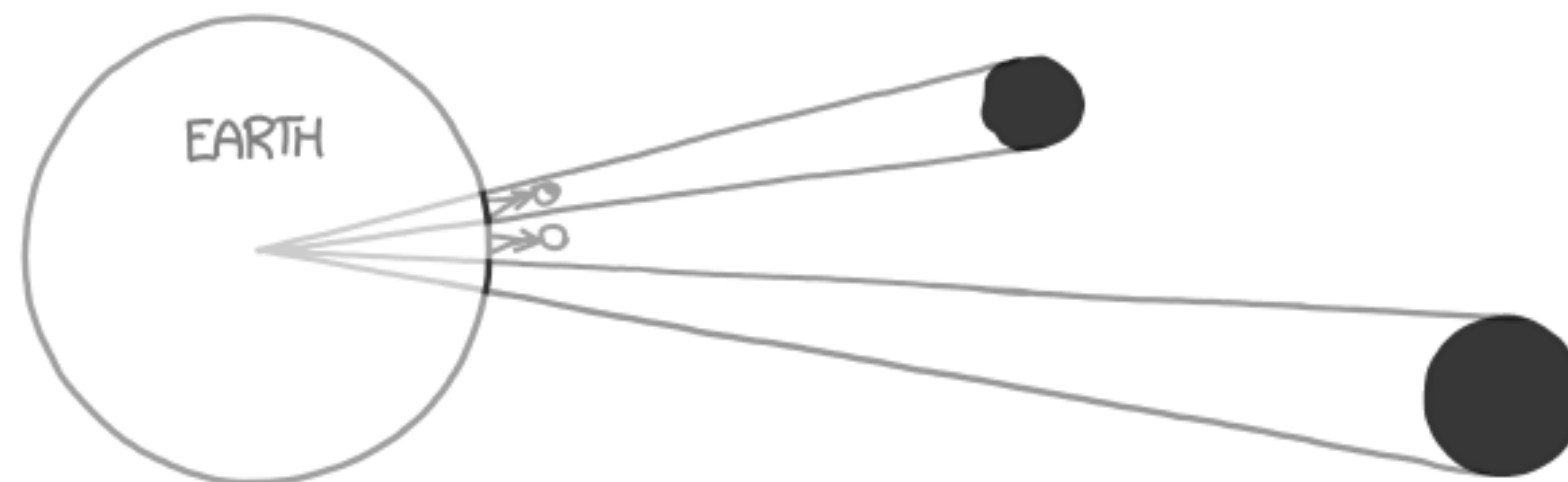

- Sun and moon both subtend $\sim 60\mu$ sr as seen from earth

- Surface area of earth: $\sim 510\text{M km}^2$

- Projected area:

$$510\text{Mkm}^2 \frac{60\mu\text{sr}}{4\pi\text{sr}} = 510 \frac{15}{\pi} \approx 2400\text{km}^2$$

<http://xkcd.com/1276/>

Differential solid angle

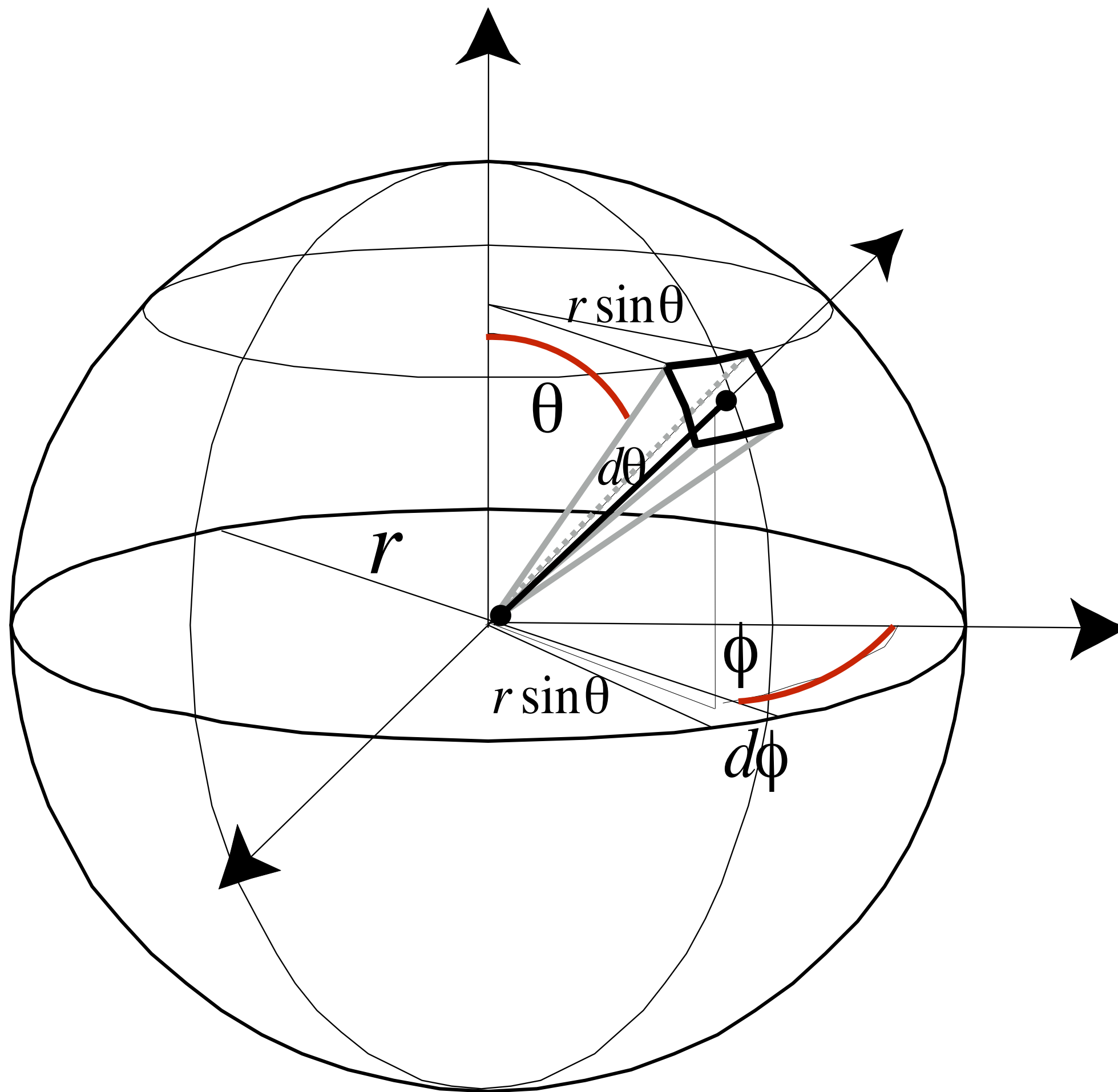

Consider a tiny area swept out by a tiny angle in each direction...

$$\begin{aligned}dA &= (r d\theta)(r \sin \theta d\phi) \\ &= r^2 \sin \theta d\theta d\phi\end{aligned}$$

$$d\omega = \frac{dA}{r^2} = \sin \theta d\theta d\phi$$

Differential solid angle is just that same tiny area projected onto the *unit sphere*

Differential solid angle

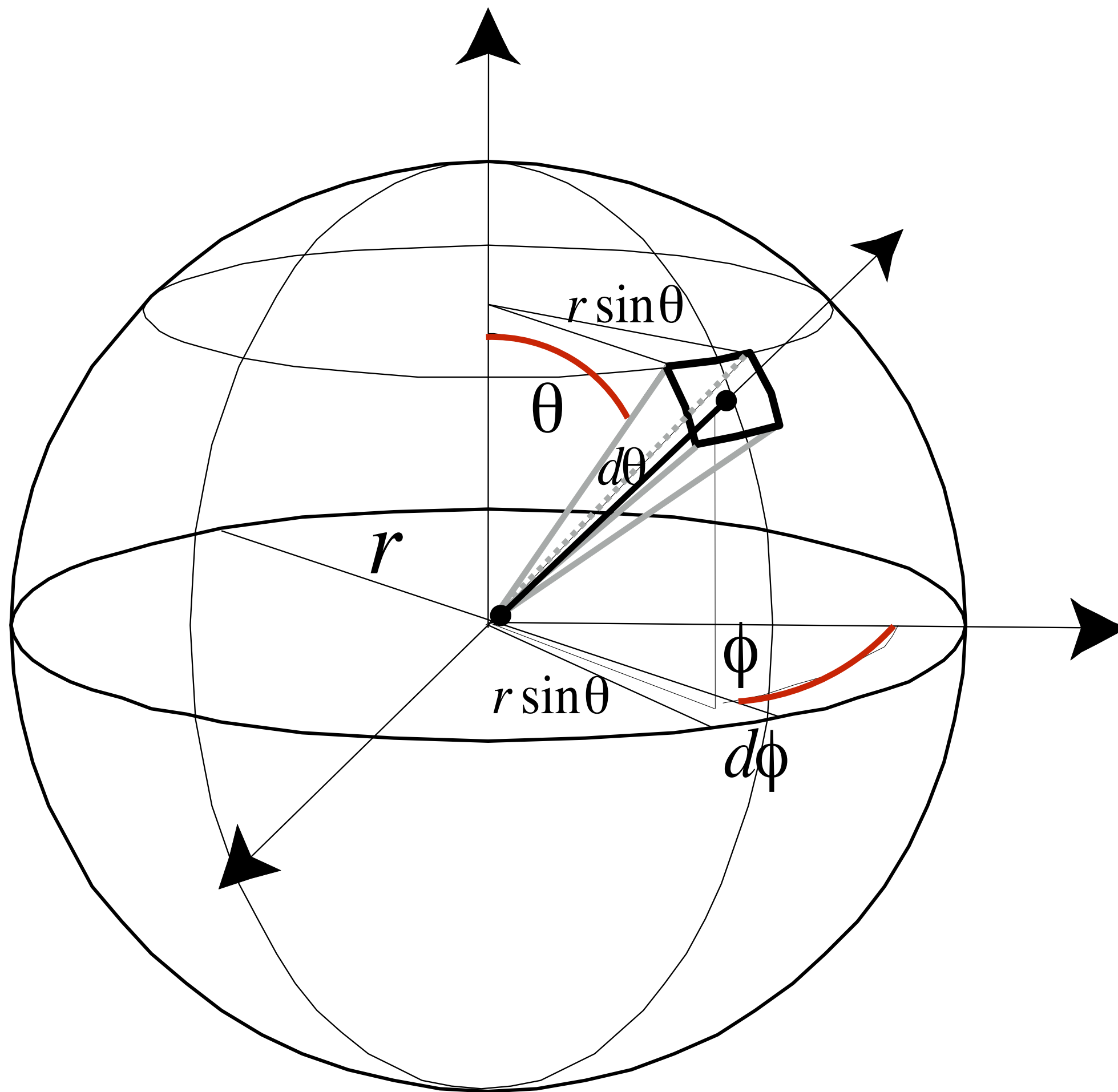

$$\begin{aligned}\Omega &= \int_{S^2} d\omega \\ &= \int_0^{2\pi} \int_0^\pi \sin \theta \, d\theta \, d\phi \\ &= 4\pi\end{aligned}$$

ω as a direction vector

Will use ω to denote a direction vector (unit length)

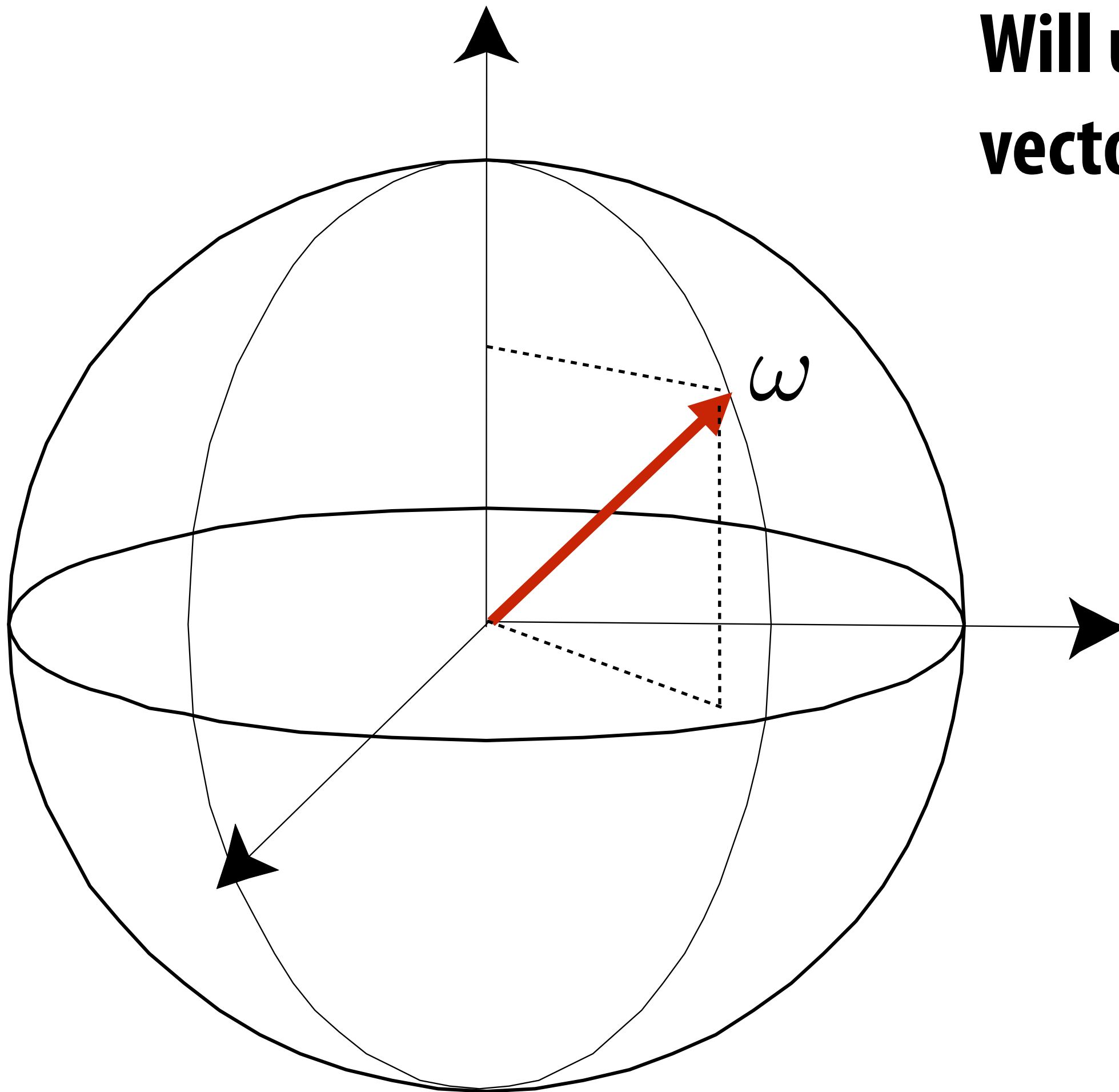

Radiance

- **Radiance is the solid angle density of irradiance**

$$L(p, \omega) = \lim_{\Delta \rightarrow 0} \frac{\Delta E_\omega(p)}{\Delta \omega} = \frac{dE_\omega(p)}{d\omega} \left[\frac{\text{W}}{\text{m}^2 \text{ sr}} \right]$$

where E_ω denotes that the differential surface area is oriented to face in the direction ω

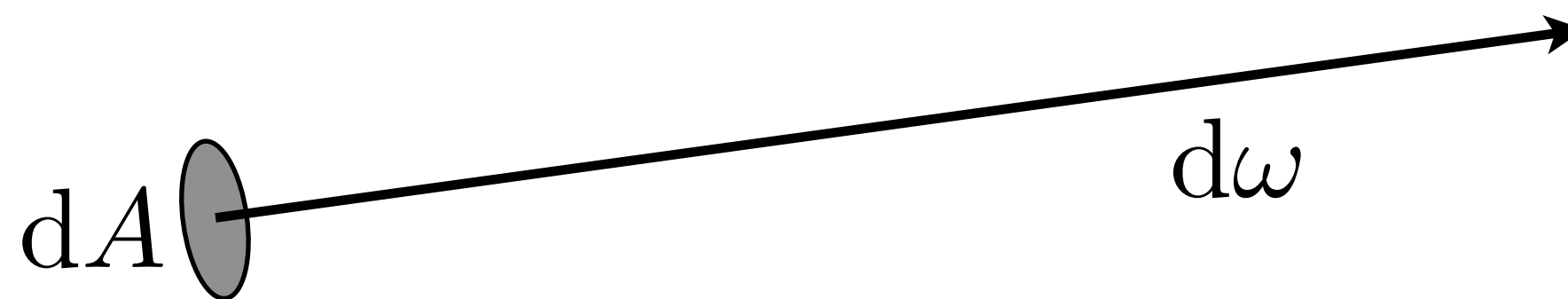

In other words, radiance is energy along a ray defined by origin point p and direction ω

Energy per unit time per unit area per unit solid angle...!

Surface Radiance

- Equivalently,

$$L(p, \omega) = \frac{dE(p)}{d\omega \cos \theta} = \frac{d^2\Phi(p)}{dA d\omega \cos \theta}$$

- Previous slide described measuring radiance at a surface *oriented in ray direction*
 - **cos(theta) accounts for different surface orientation**

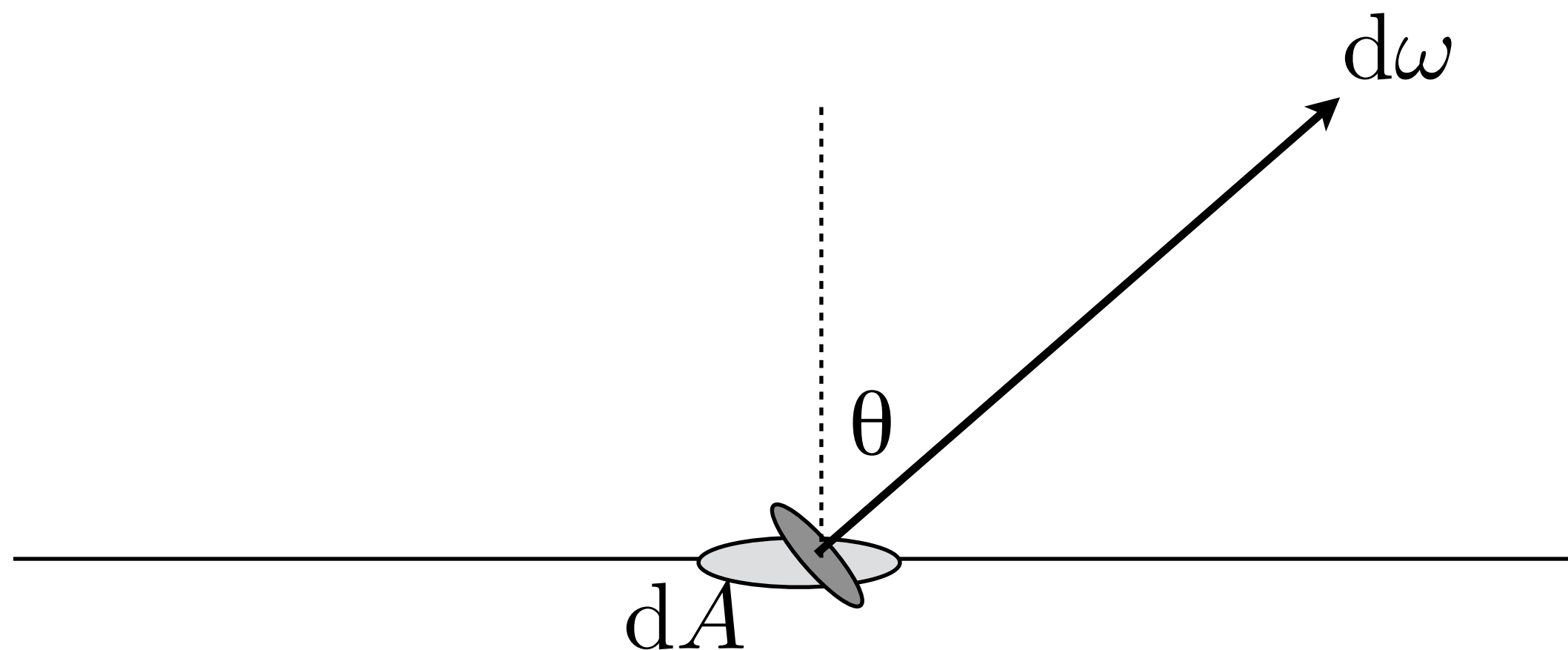

Spectral Radiance

- To summarize, radiance is: **radiant energy per unit time per unit area per unit solid angle**
- To really get a complete description of light we have to break this down just one more step: **radiant energy per unit time per unit area per unit solid angle *per unit wavelength***
- Q: What additional information do we now get?
- A: Color!



Why do we break energy down to this granularity? (spectral radiance)

Because once we have spectral radiance, we have a *complete* description of the light in an environment!

Field radiance: the light field

- Light field = radiance function on rays
- Radiance is constant along rays *
- Spherical gantry: captures 4D light field (all light leaving object)

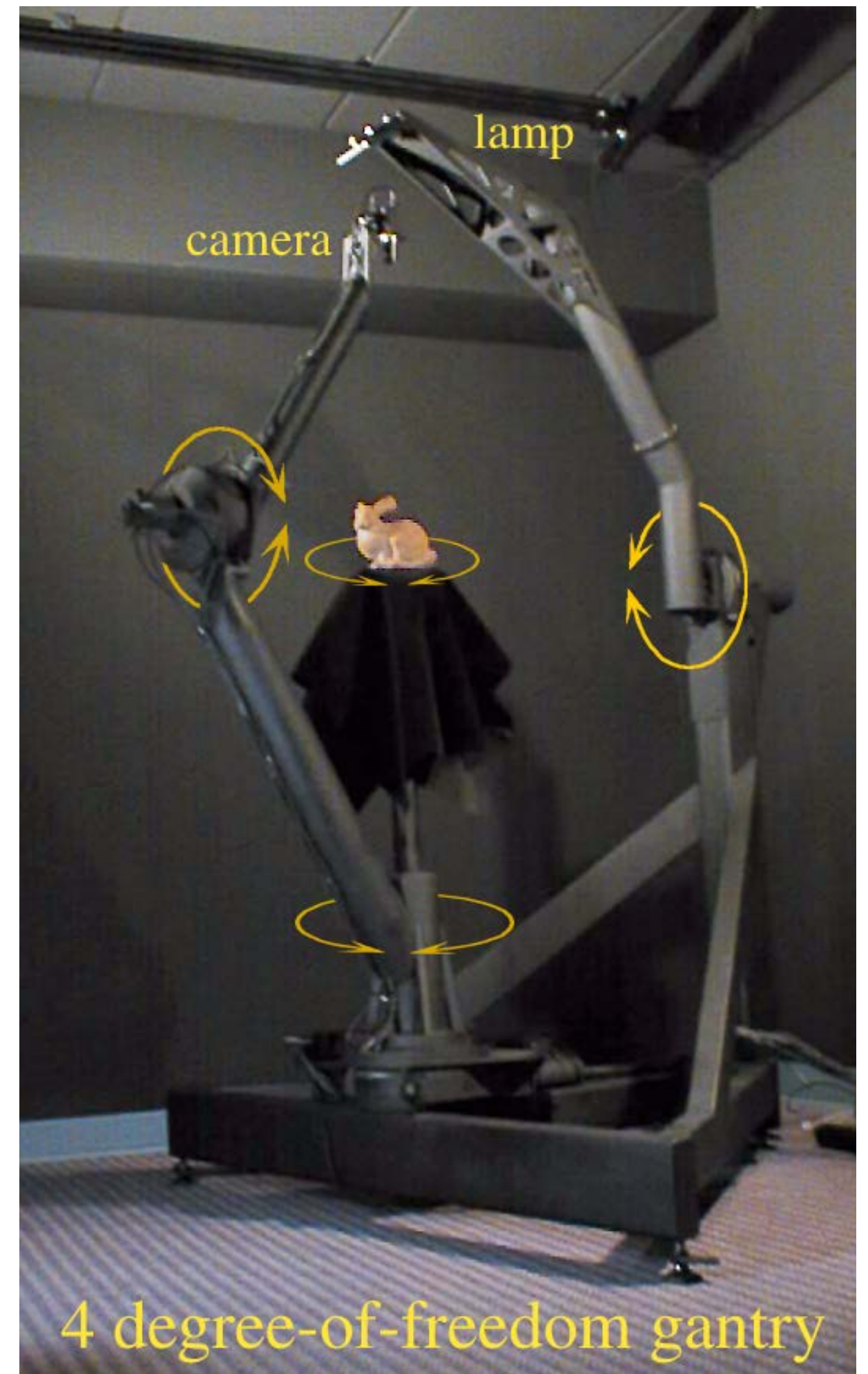
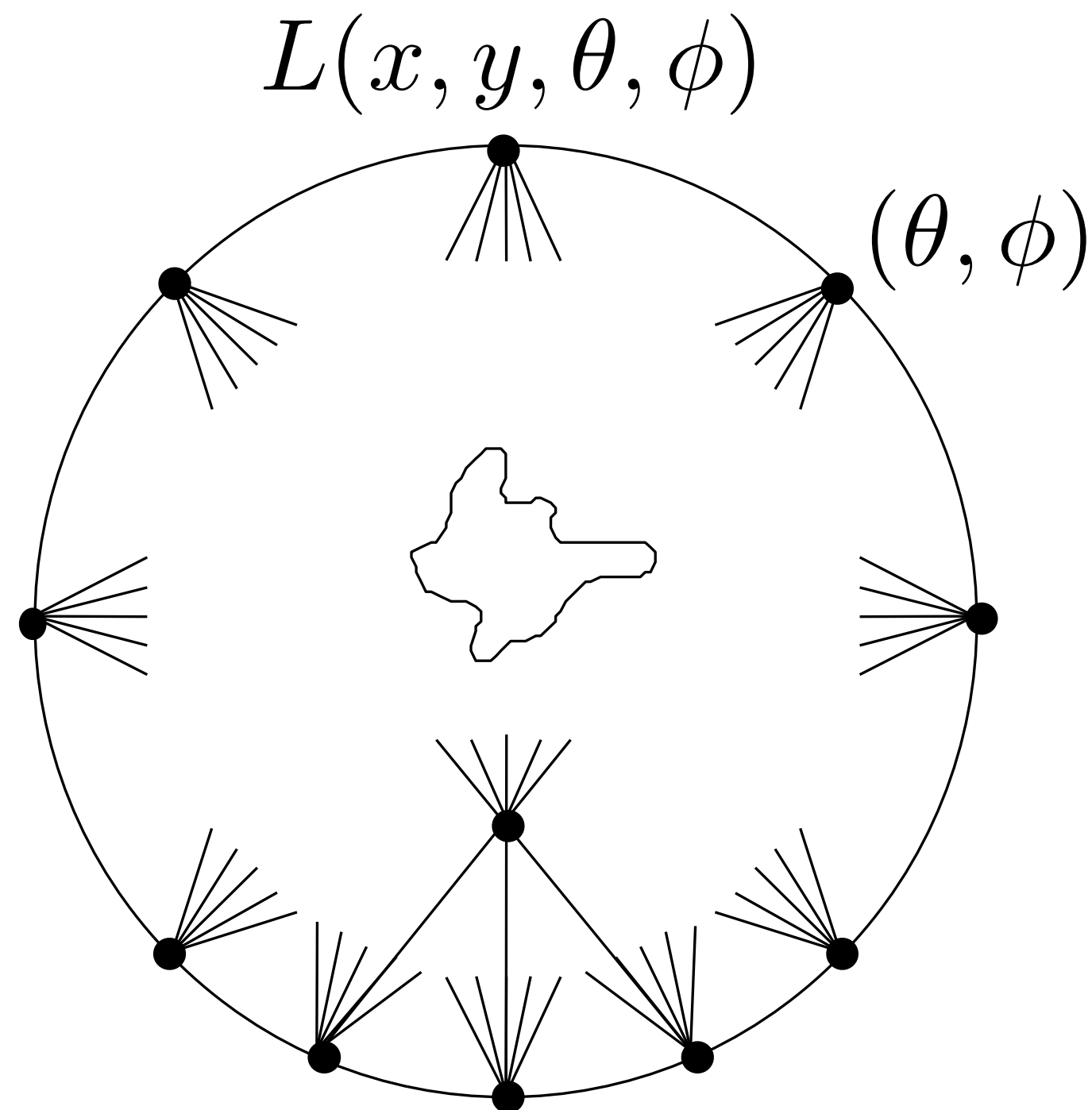

* in a vacuum

Light Field Photography

- A standard camera captures a small “slice” of the light field
- Light field cameras capture a “bigger slice,” recombine information to get new images *after* taking the photo



Incident vs. Exitant Radiance

- Often need to distinguish between incident radiance and exitant radiance functions at a point on a surface

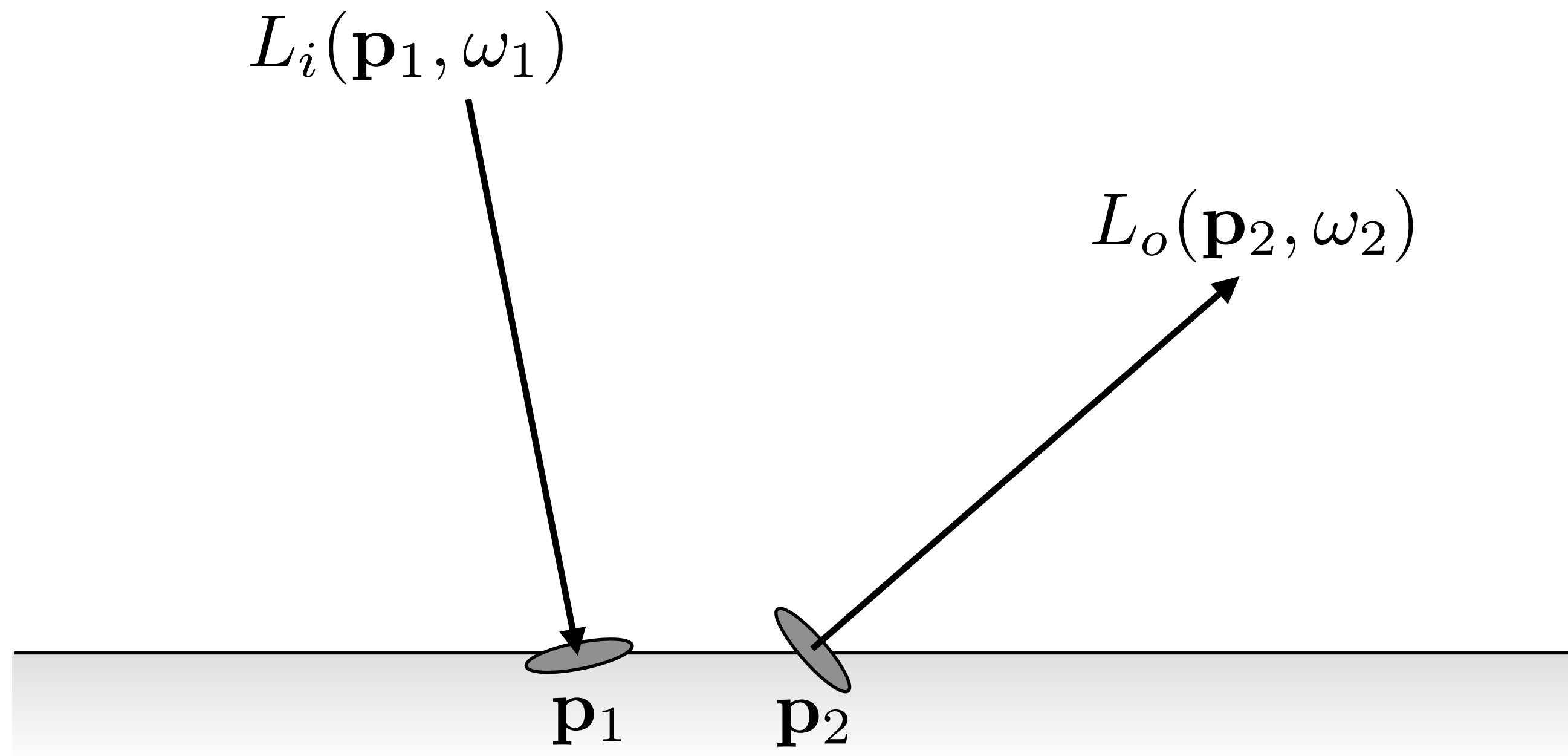

In general: $L_i(\mathbf{p}, \omega) \neq L_o(\mathbf{p}, \omega)$

Properties of radiance

- Radiance is a fundamental field quantity that characterizes the distribution of light in an environment
 - Radiance is the quantity associated with a ray
 - *Rendering is all about computing radiance*
- Radiance is constant along a ray (in a vacuum)
- A pinhole camera measures radiance

Irradiance from the environment

Computing flux per unit area on surface, due to incoming light from all directions:

$$E(\mathbf{p}) = \int_{H^2} L_i(\mathbf{p}, \omega) \cos \theta d\omega$$

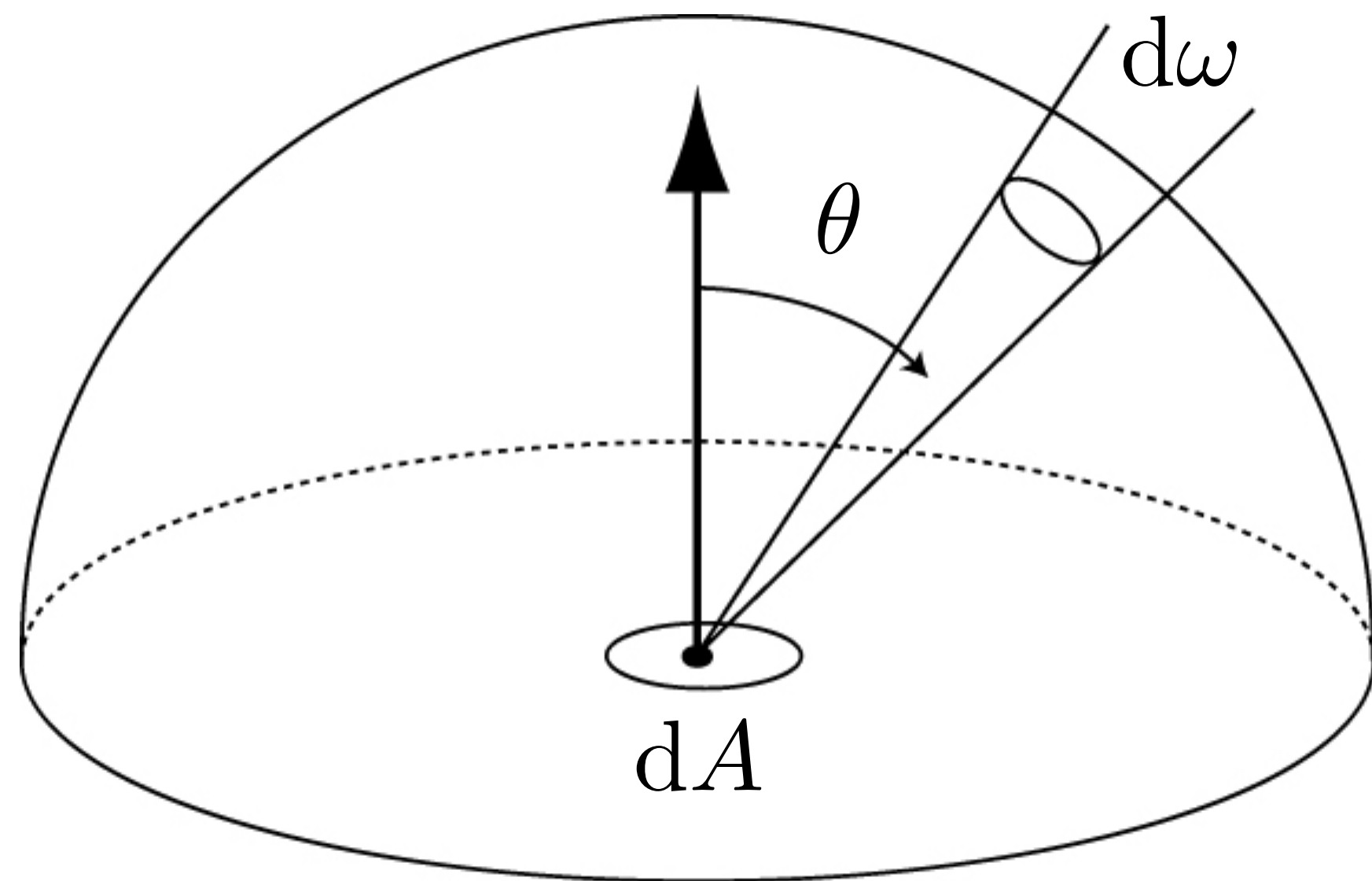

(This is what we often want to do for rendering!)

Simple case: irradiance from uniform hemispherical source

$$\begin{aligned} E(p) &= \int_{H^2} L \, d\omega \\ &= L \int_0^{2\pi} \int_0^{\frac{\pi}{2}} \cos \theta \sin \theta \, d\theta \, d\phi \\ &= L\pi \end{aligned}$$

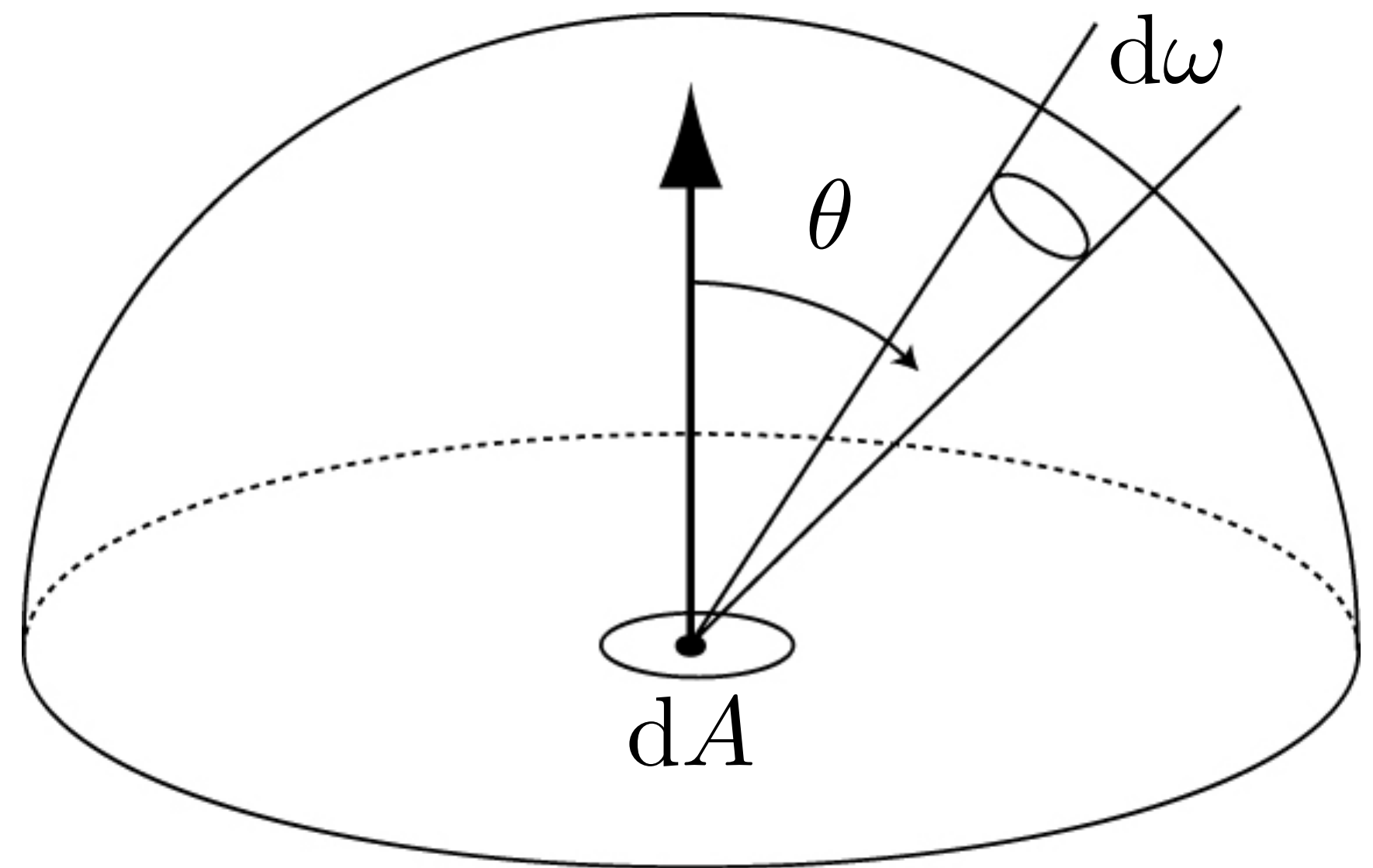

Example of hemispherical light source



Q: Why didn't we just get the same constant $L\pi$ (white) at every point?

Ambient occlusion

- Assume *spherical* (vs. hemispherical) light source, “at infinity”
- Irradiance is now rotation, translation invariant
- Can pre-compute, “bake” into texture to enhance shading

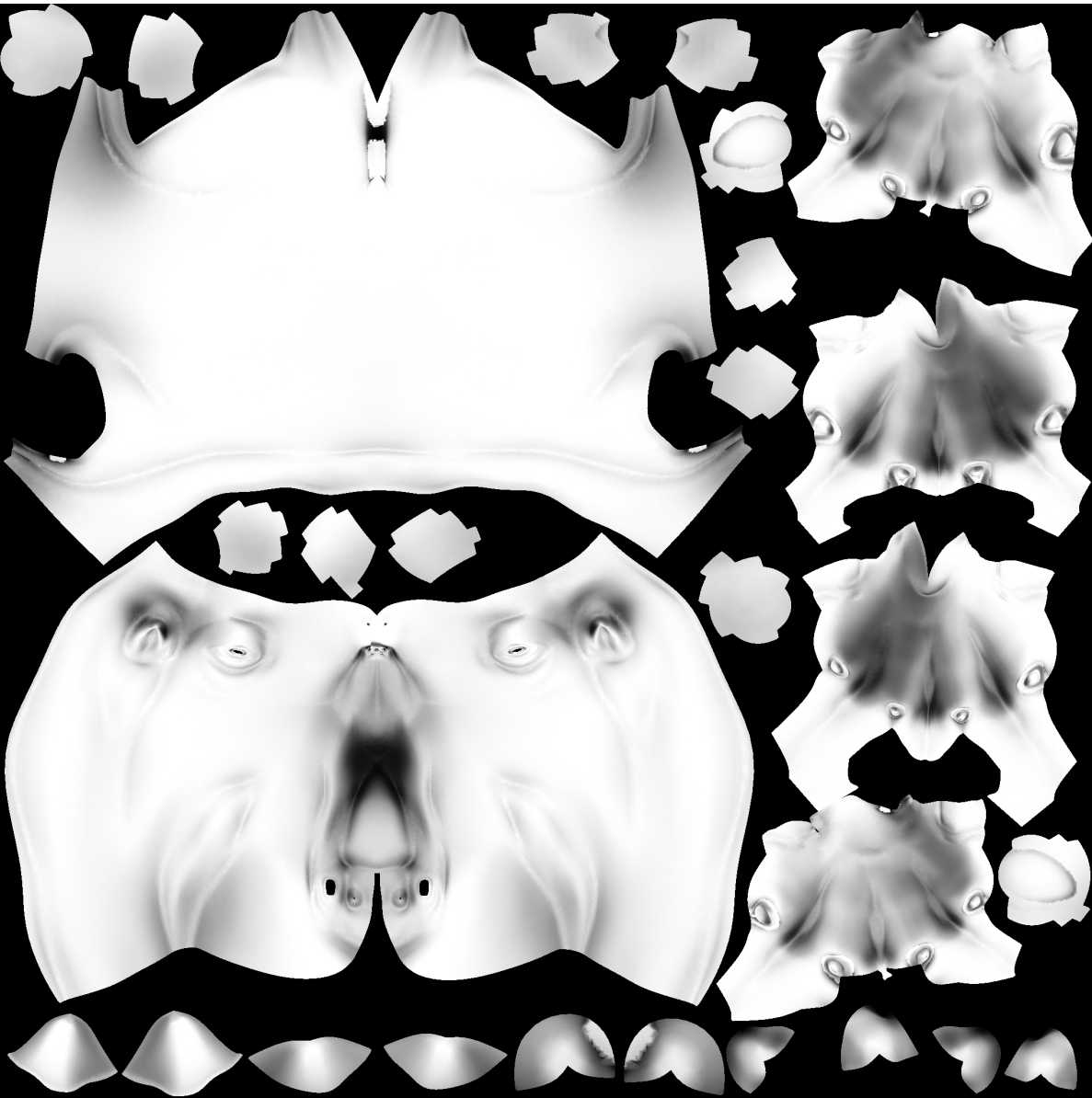

ambient occlusion map

without A0 map

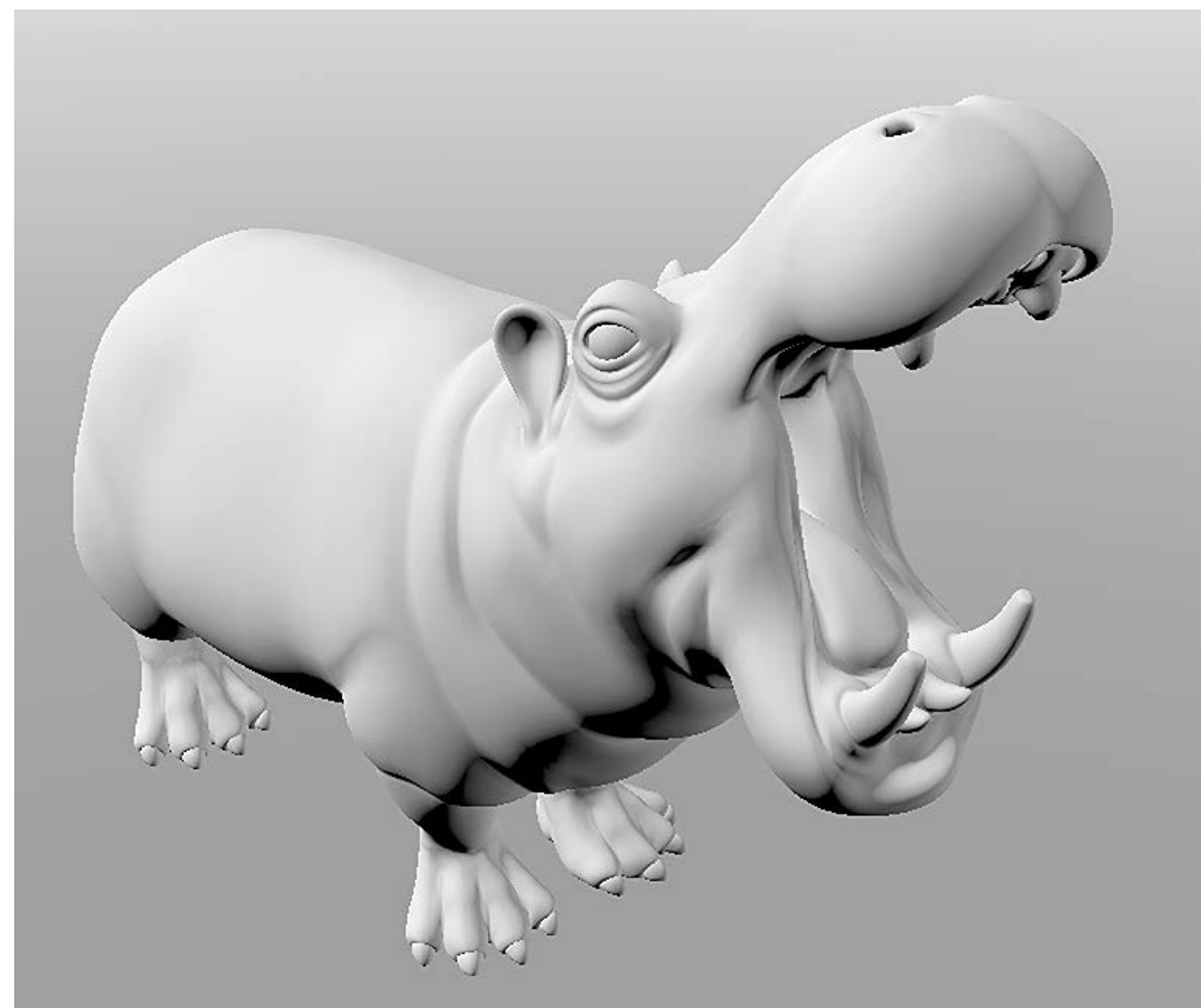

with A0 map

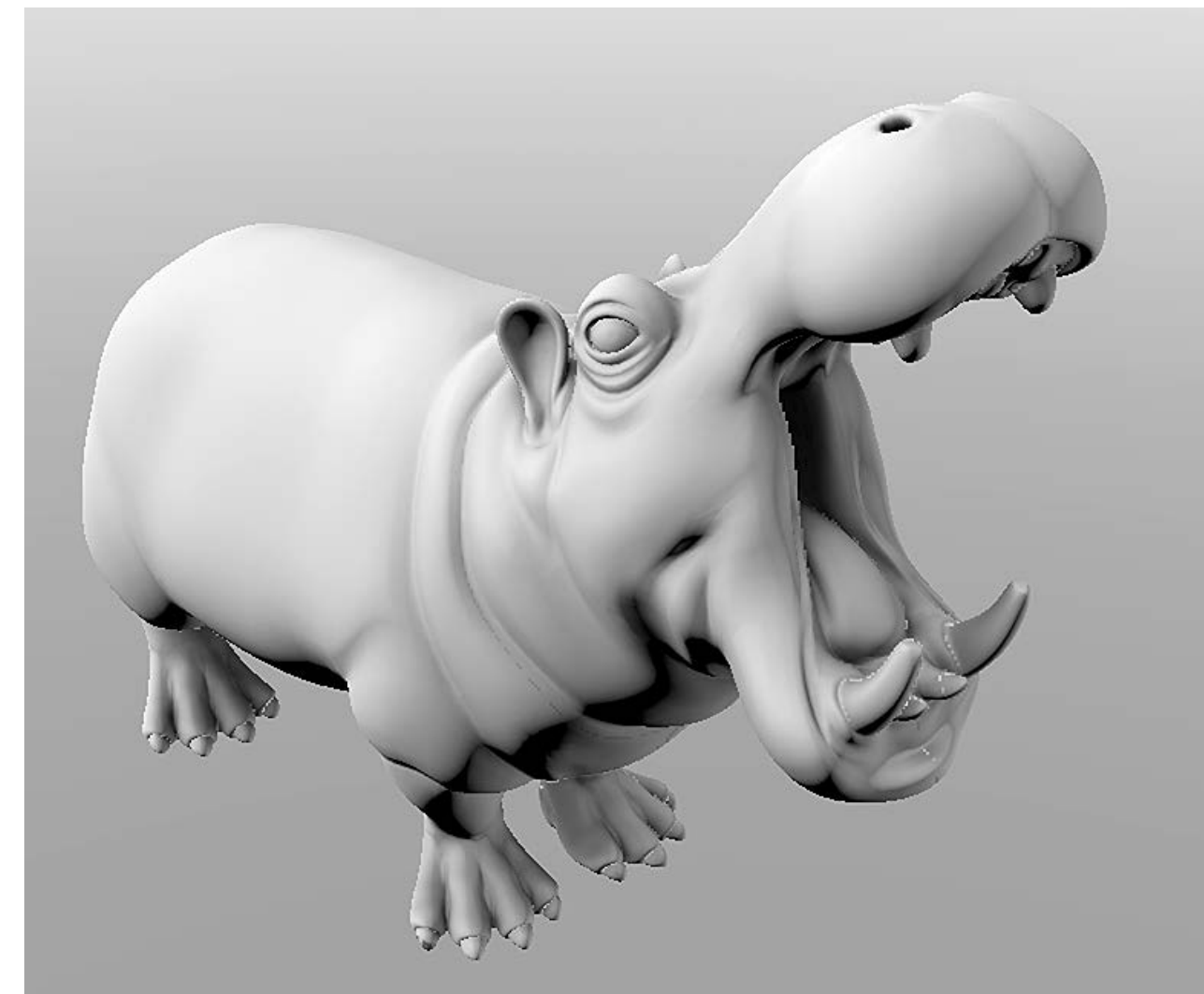

Screen-space ambient occlusion



Screen-space ambient occlusion



Screen-space ambient occlusion



Irradiance from a uniform area source

(source emits radiance L)

$$\begin{aligned} E(p) &= \int_{H^2} L(p, \omega) \cos \theta \, d\omega \\ &= L \int_{\Omega} \cos \theta \, d\omega \\ &= L\Omega^\perp \end{aligned}$$

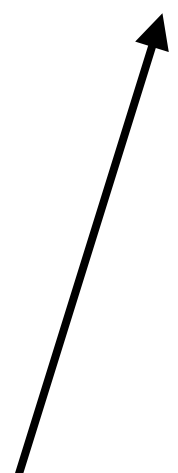

Projected solid angle:

- **Cosine-weighted solid angle**
- **Area of object O projected onto unit sphere, then projected onto plane**

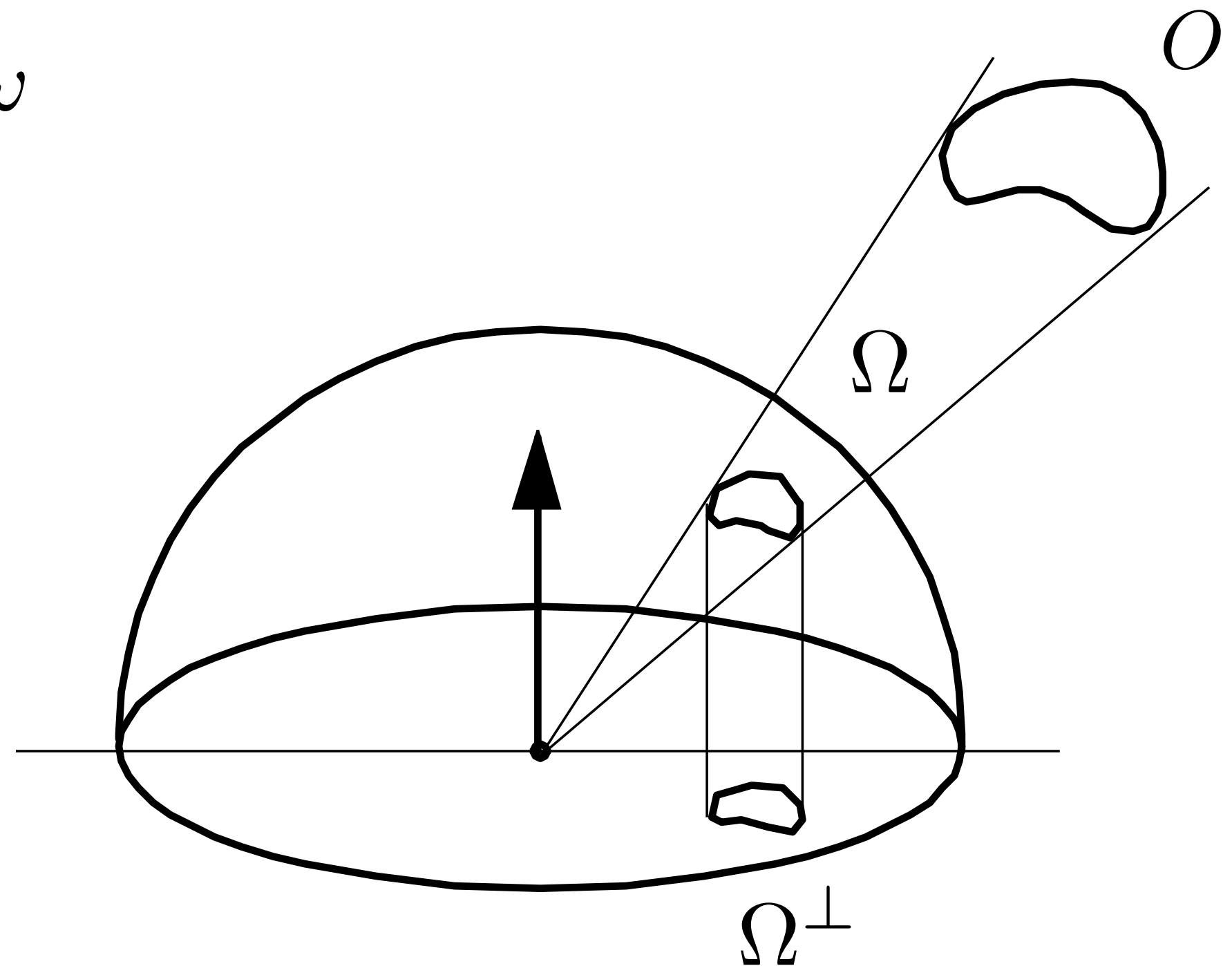

$$d\omega^\perp = |\cos \theta| \, d\omega$$

Uniform disk source (oriented perpendicular to plane)

Geometric Derivation (using projected solid angle)

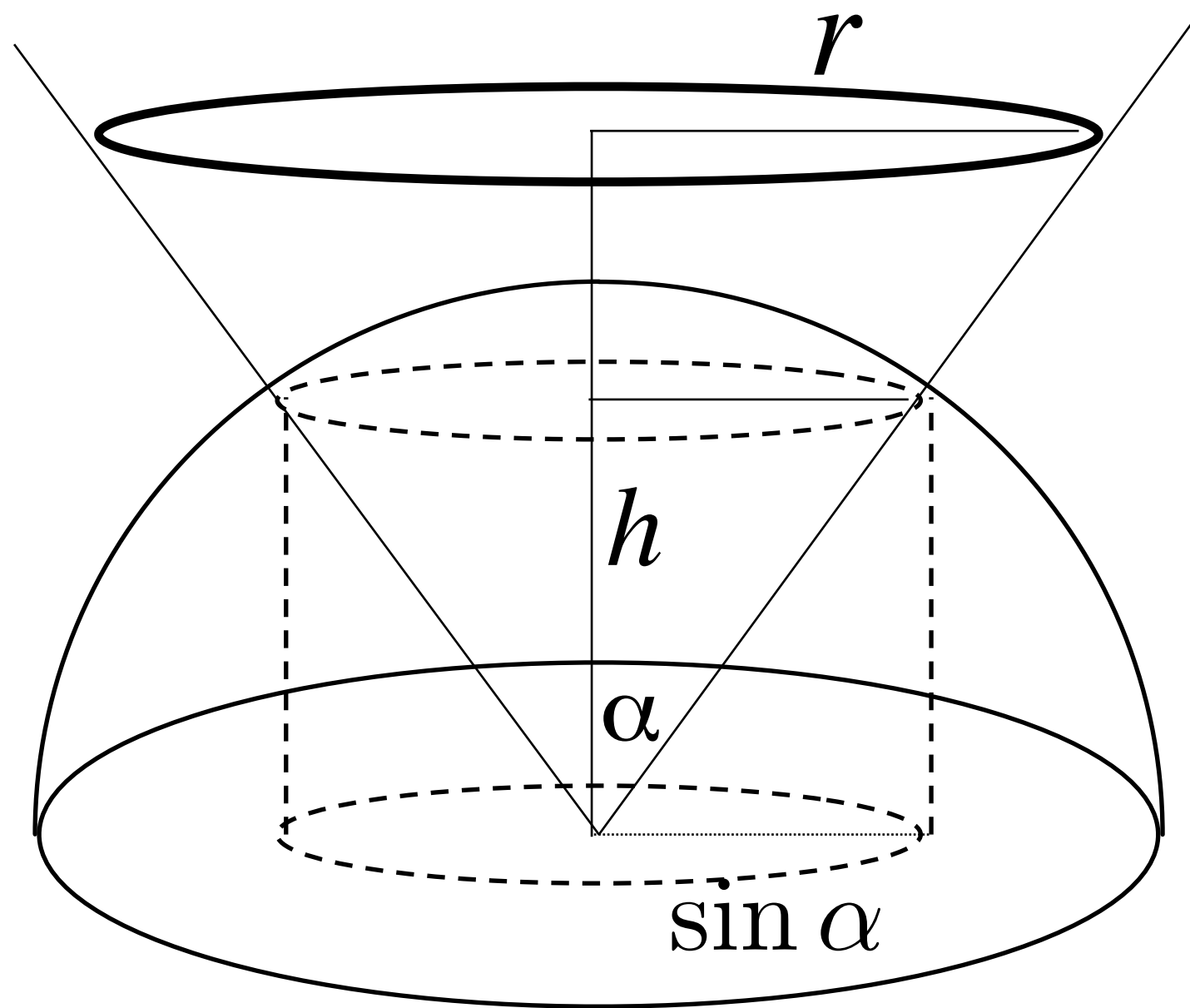

$$\Omega^{\perp} = \pi \sin^2 \alpha$$

Algebraic Derivation

$$\begin{aligned}\Omega^{\perp} &= \int_0^{2\pi} \int_0^{\alpha} \cos \theta \sin \theta \, d\theta \, d\phi \\ &= 2\pi \left. \frac{\sin^2 \theta}{2} \right|_0^{\alpha} \\ &= \pi \sin^2 \alpha\end{aligned}$$

Examples of Area Light Sources

Generally “softer” appearance than point lights:

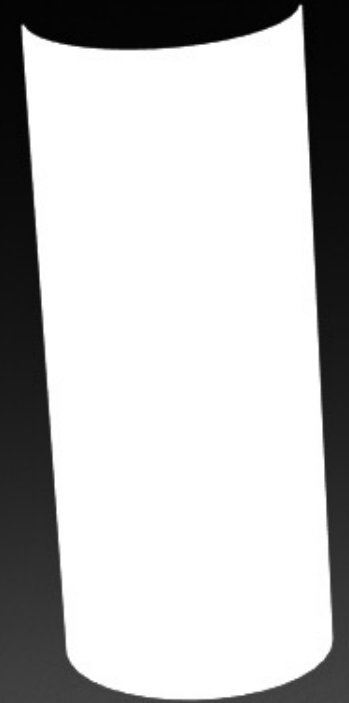
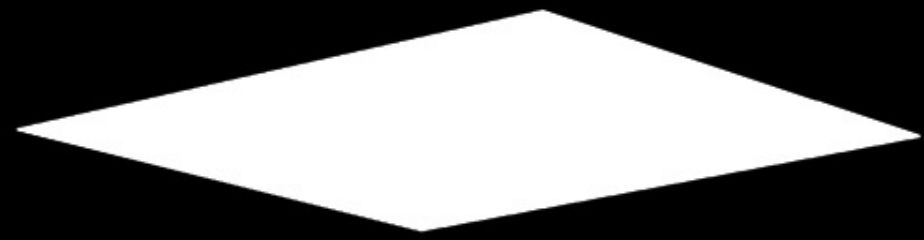

...and better model of real-world lights!

Measuring illumination: radiant intensity

- Power per solid angle emanating from a point source

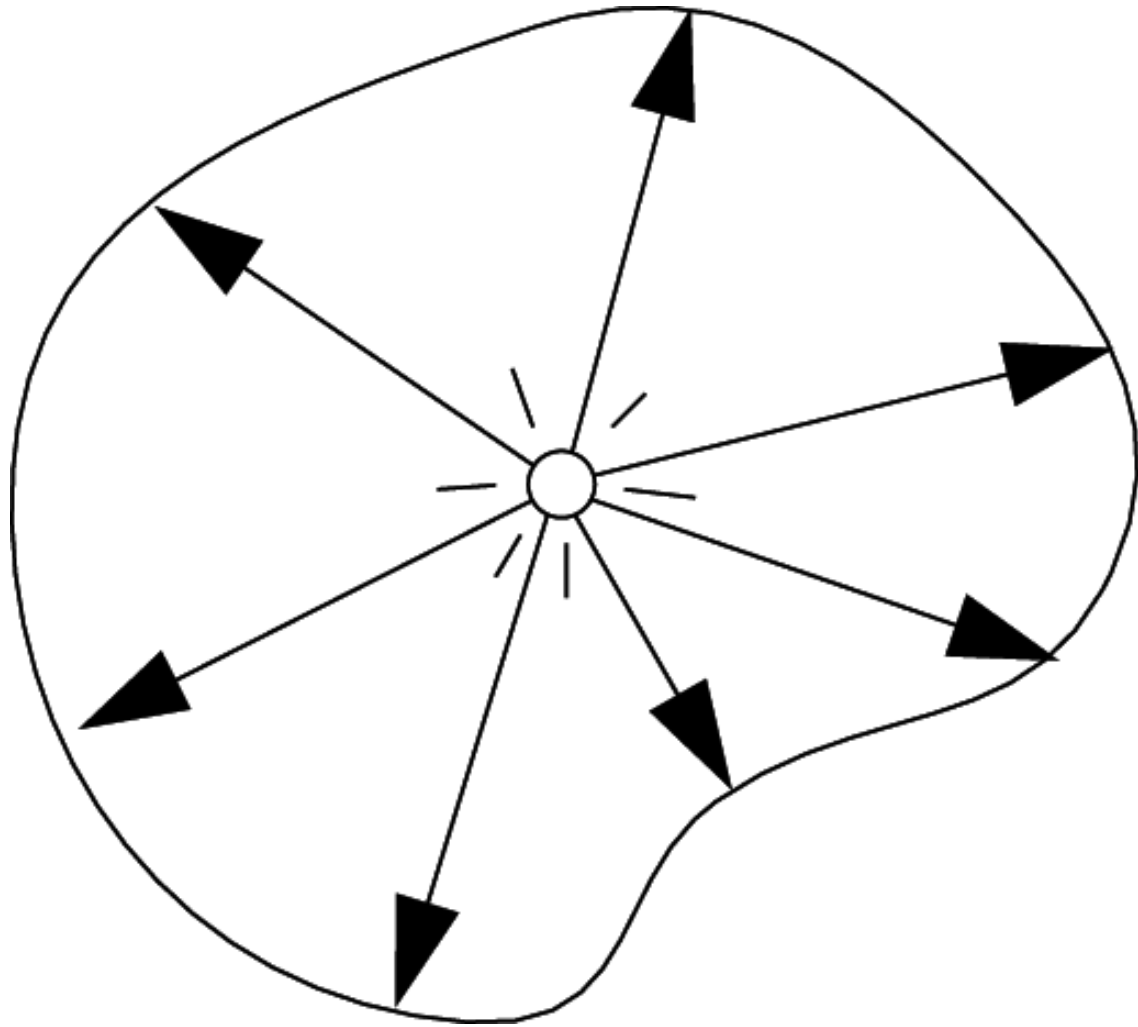

$$I(\omega) = \frac{d\Phi}{d\omega} \left[\frac{\text{W}}{\text{sr}} \right]$$

More realistic light models via “goniometry”

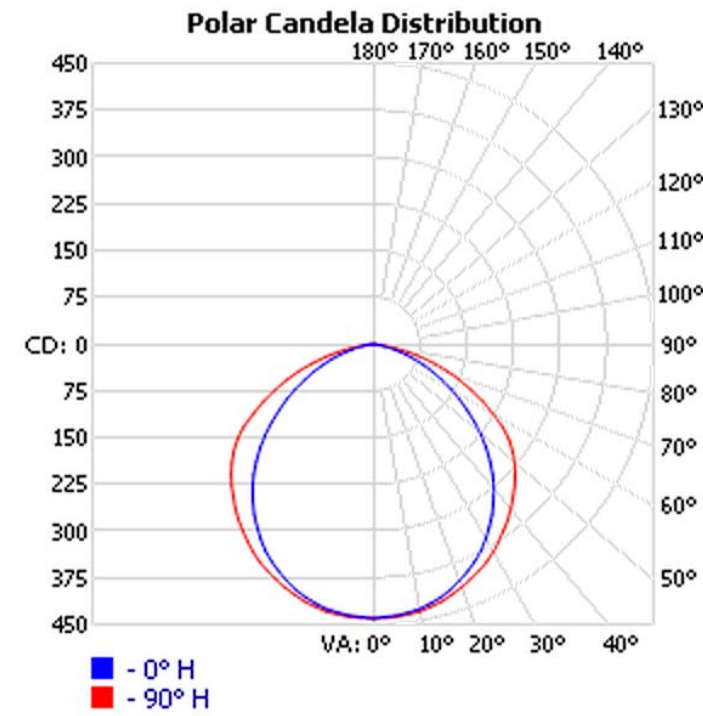
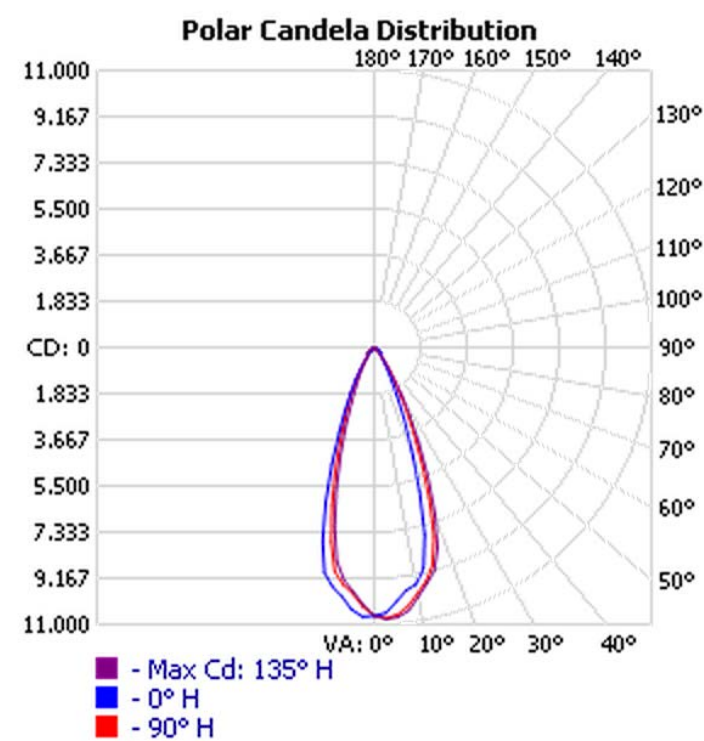

Goniometric diagram measures light intensity as function of angle.

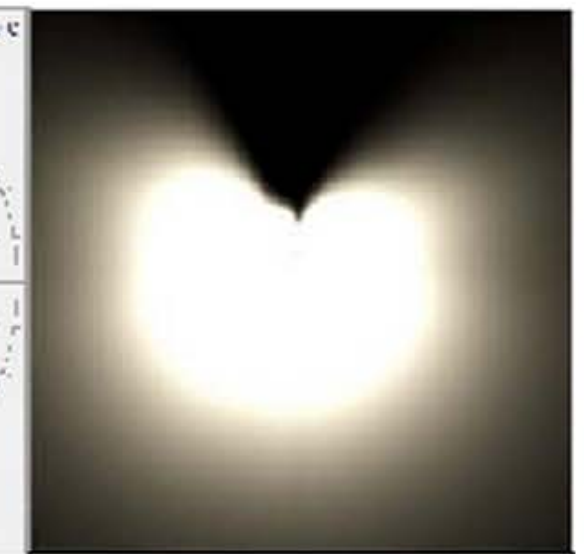
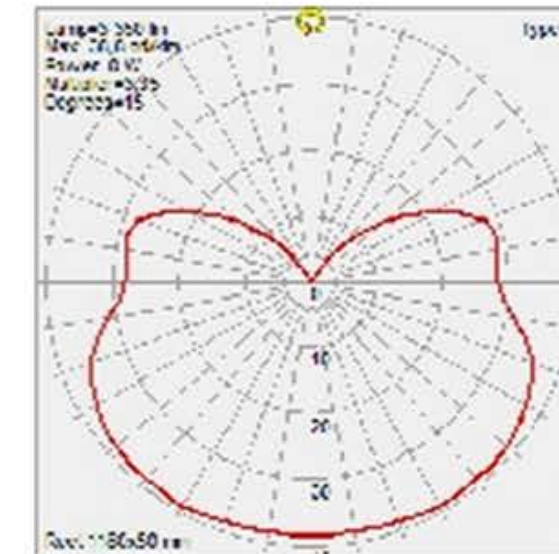
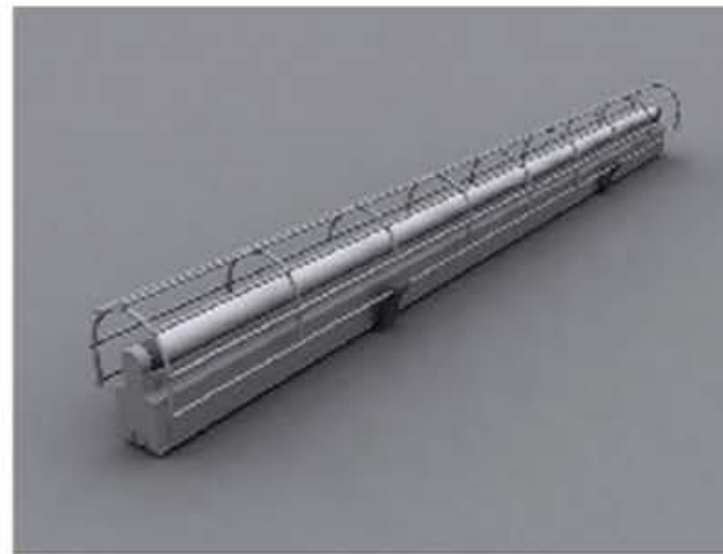
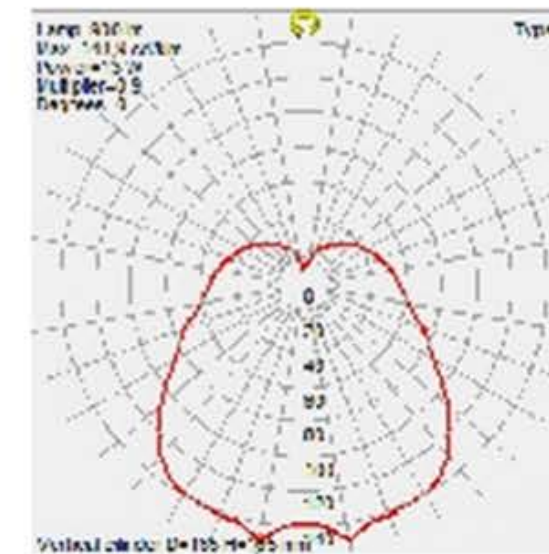
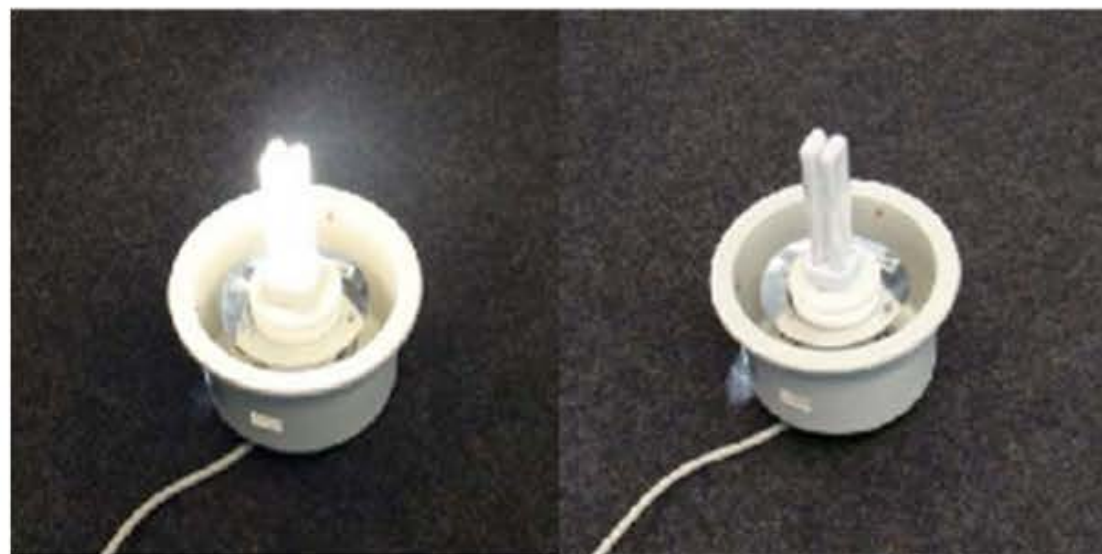

<http://www.mpi-inf.mpg.de/resources/mpimodel/v1.0/luminaires/index.html>

<http://www.visual-3d.com/tools/photometricviewer/>

Photometry: light + humans

- All radiometric quantities have equivalents in photometry
- Photometry: accounts for response of human visual system to electromagnetic radiation $V(\lambda)$
- Luminance (Y) is photometric quantity that corresponds to radiance: integrate radiance over all wavelengths, weight by eye's luminous efficacy curve, e.g.:

$$Y(p, \omega) = \int_0^{\infty} L(p, \omega, \lambda) V(\lambda) d\lambda$$

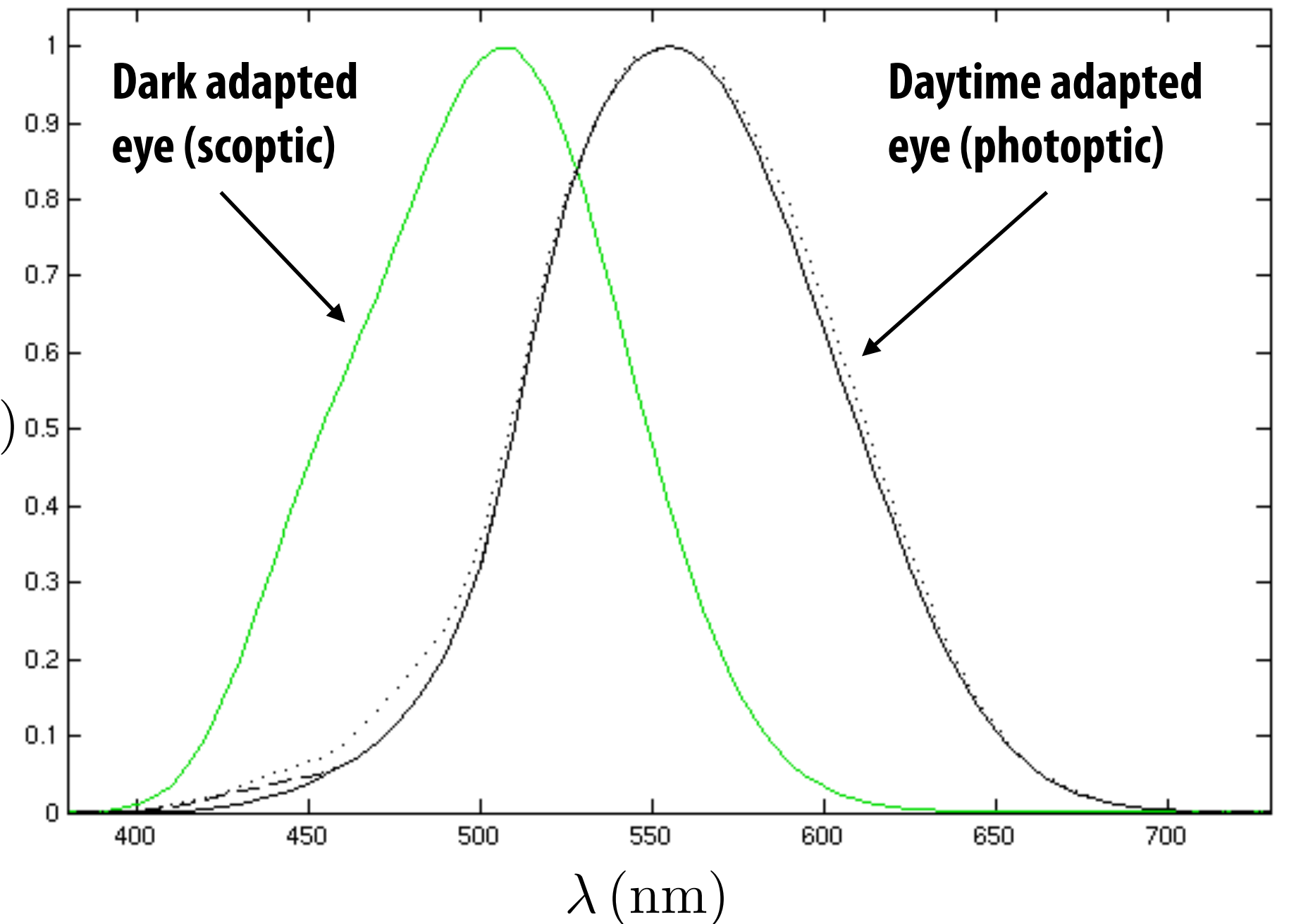

Radiometric and photometric terms

Physics	Radiometry	Photometry
Energy	Radiant Energy	Luminous Energy
Flux (Power)	Radiant Power	Luminous Power
Flux Density	Irradiance (incoming) Radiosity (outgoing)	Illuminance (incoming) Luminosity (outgoing)
Angular Flux Density	Radiance	Luminance
Intensity	Radiant Intensity	Luminous Intensity

Photometric Units

Photometry	MKS	CGS	British
Luminous Energy	Talbot	Talbot	Talbot
Luminous Power	Lumen	Lumen	Lumen
Illuminance Luminosity	Lux	Phot	Footcandle
Luminance	Nit, Apostlib, Blondel	Stilb Lambert	Footlambert
Luminous Intensity	Candela	Candela	Candela

“Thus one nit is one lux per steradian is one candela per square meter is one lumen per square meter per steradian. Got it?” —*James Kajiya*

What information are we missing?

- At the beginning, adopted “geometric optics” model of light
- Miss out on small-scale effects (e.g., diffraction/iridescence)
- Also large-scale effects (e.g., bending of light due to gravity)

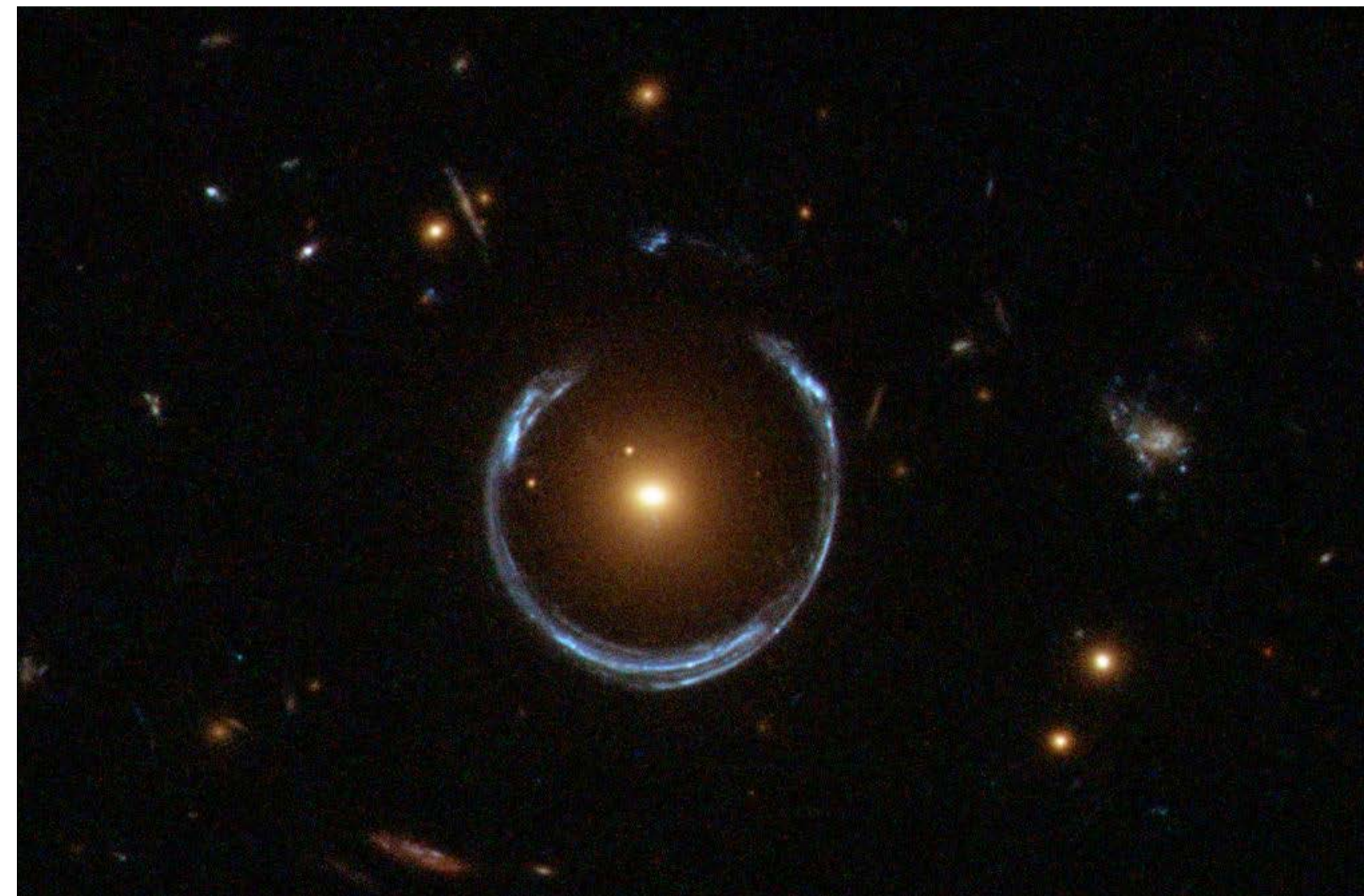

Next time...

- More toward our goal of realistic rendering
- Materials, scattering, etc.

